

Digital Pressure Sensor

LED Display with Switch & Analog Outputs



measuring
•
monitoring
•
analyzing

PSD



- Measuring Range: 0...30 to 0...7500 PSI
- Temperature Range: -13...185 °F
- Accuracy (at 77 °F): $\pm 0.5\%$ FS
- Connection: 1/4" NPT
- Analog Output: Switchable mA or V
- Switching Output: 2 PNP Transistors
- Adjustable Pressure Range:
50...100 % of the Nominal Range
- Display Housing and Electrical Connection
are Independently Rotatable 335°/343°
- 3-Key Programming
- OEM Pricing Available



KOBOLD companies worldwide:

ARGENTINA, AUSTRALIA, AUSTRIA, BELGIUM, BULGARIA, CANADA, CHILE, CHINA, COLOMBIA, CZECH REPUBLIC, EGYPT, FRANCE, GERMANY, HUNGARY, INDIA, INDONESIA, ITALY, MALAYSIA, MEXICO, NETHERLANDS, PERU, POLAND, REPUBLIC OF KOREA, ROMANIA, SINGAPORE, SPAIN, SWITZERLAND, TAIWAN, THAILAND, TUNISIA, TURKEY, UNITED KINGDOM, USA, VIETNAM

KOBOLD Instruments, Inc.
1801 Parkway View Drive
Pittsburgh, PA 15205
Main Office:
1.800.998.1020
1.412.788.4890
info@koboldusa.com
www.koboldusa.com



Description

The economical PSD offers the ideal combination of two pressure switches and a scalable transmitter output with a 45 degree viewable, rotatable display. The parameters can be set directly on the device. Within the settings, there are a comprehensive set of options, making the PSD suitable for a wide range of demanding applications. There is integral hysteresis, window, and delay functionality included. OEM quantity pricing available upon request.

Applications

- Machine Tools
- Hydraulics
- Process Technology
- Industrial Applications
- OEM Targeted Product

Technical Details

Measuring Principle:	Thin Film
Measuring Range:	0...30 to 0...7500 PSI, Adjustable 50... 100 % FS
Output Signal:	4...20 mA 0...10 V _{DC} , Switchable mA or V
Switching Output:	2 PNP Transistors
Accuracy @ 77 °F typ.:	±0.5 % FS typ.
Media Temperature:	-13...185 °F
Ambient Temperature:	-13...185 °F
Display Units:	psi, bar, MPa, kPa, m WC, mm WC

Electrical Data

Output/Supply Voltage:	4...20 mA or 0-10 V _{DC} / 24 (15...30) V _{DC}
Switch-On Delay:	typ. 200 ms
Inverse-polarity Protection, Short-circuit Strength @ 77 °F During 5 min.:	Integrated
Current Consumption:	≤30 mA

Environmental Conditions

Media Temperature:	-13...185 °F
Ambient Temperature:	-13...185 °F
Protection¹⁾:	IP65
Humidity:	Max. 95 % Relative
Vibration:	10 g (10...2000 Hz)
Shock:	50 g/3 ms

¹⁾ See »Electrical Connection«

Analog Output

Output Signal:	4-20 mA or 0-10 V _{DC}
Accuracy:	TEB ²⁾ @ -13...185 °F [% FS typ.] ±1.75 Accuracy @ 77 °F [% FS typ.] ±0.5 NLH ²⁾ @ 77 °F (BSL ²⁾) [% FS typ.] ±0.2 TC ²⁾ Zero Point and Span [% FS/K typ.] ±0.03 Long Term Stability 1 Year [% FS typ.] ±0.1

Current Limiting

Output Signal:	4-20 mA: 25 mA (Overload) 0...10 V _{DC} : <40 mA (Short-circuit)
-----------------------	--

Damping (Rise Time):	0.01 ...3.00 s/10...90 % Nominal Pressure
-----------------------------	--

Switching Output

Accuracy:	Accuracy @ 77 °F [% FS typ.] ±0.5 TEB ²⁾ @ -13...185 °F [% FS typ.] ±1.0 Long Term Stability 1 Year [% FS typ.] ≤±0.3
------------------	---

Adjustment Range of

Switchpoints:	0...100 % FS
Switching Hysteresis:	≥1 % FS Switchpoint >Reset Point
Switching Resistance:	≤3 Ω
Output Function:	Hysteresis, Window; Normally Closed (NC), Normally Open (NO)
Switching Current:	≤0.5 A Each Switching Output
Current Limiting:	≤2 A Each Switching Output
Switching Frequency:	Max. 200 Hz
Delay Time:	0...99.99 s

Display

Display:	4-Digit, 7-Segment Display, 180° Flippable with Disable Function Standard Decimal Places: ≤9: 3 Decimal Places 10...99: 2 Decimal Places 100...999: 1 Decimal Place
-----------------	--

Switching Status

Indication:	2 LED, Red
Operation:	with 3 Buttons and Menu Navigation According to VDMA 24574-1

Display Resolution:	0.1 % FS
Display Range:	-3...103 % FS
Setting Parameters:	See Parameter Table, pg 4

²⁾ See Terminology Section on page 6



Mechanical Data

Sensor (Wetted Parts): 1.4542 (AISI630)
Pressure Connection (Wetted Parts): 1.4542 (AISI630)
Housing: Steel, Die Cast Metal Galvanized
 Display Housing Plastic
Connection: 1/4" NPT
Male Electrical Plug: PA-plug M12x1.5-pin
Mounting Torque: 15 ... 20 Nm
Housing Alignment: Display 335° Rotatable,
 Max. 2.5 Nm
 Electrical Connection 343°
 Rotatable, Max. 5 Nm

Surge Damping

Orifice: Ø 0.4 mm
Weight: ~189 g

Overpressure and Burst Pressure

Range (PSI)	Overpressure (PSI)	Burst Pressure (PSI)
0..30	90	700
0...50	150	850
0...100	300	1450
0...150	450	2500
0...200	600	2500
0...300	900	4000
0...500	1500	4000
0...1000	3000	5000
0...1500	4500	7000
0...2000	6000	10000
0...3000	9000	14500
0...5000	12500	21750
0...7500	18750	29000

Measuring Accuracy 0.5 %

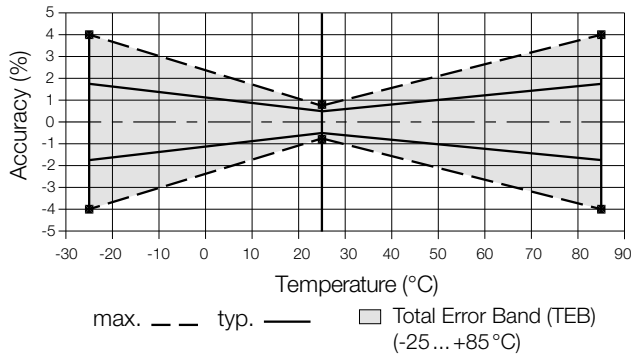

Order Details (Example: PSD-4 3 3 N2 P045)

Model	Version	Electrical Connection	Material	Connection	Measuring Range	Option
PSD-..	..4.. = 2xPNP Switching Output, Analog Output 4-20 mA or 0-10 V _{DC}	..3.. = M12 Plug, 24 (15-30) V _{DC}	..3.. = Stainless Steel Connection	..N2.. = 1/4" NPT Male	..P045 = 0...30 psi ..P055 = 0...50 psi ..P065 = 0...100 psi ..P075 = 0...150 psi ..P085 = 0...200 psi ..P090 = 0...300 psi ..P100 = 0...500 psi ..P115 = 0...1000 psi ..P126 = 0...1500 psi ..P130 = 0...2000 psi ..P140 = 0...3000 psi ..P150 = 0...5000 psi ..P170 = 0...7500 psi	..40 = Surge Damping Orifice D = 0.4 mm



Accessories

Model Number	Cable Length	Description	Number of Contacts
807.007	2 meters (6 feet)	M12 Accessory Cable	5
807.007/5M	5 meters (16 feet)	M12 Accessory Cable	5
807.007/10M	10 meters (32 feet)	M12 Accessory Cable	5
ZUB-KAB-12D500	NA	M12 box, screw connection	5

Parameter

Name	Standard Setting	Value Range	Short Name
Switch Point SP1 (Hysteresis Mode) Upper Switch Point FH1 (Window Mode)	75 % Measuring Range	SP1 > RP1 FH1 > FL1 Hysteresis ≥ 1 % FS	SP1
Reset Point RP1 (Hysteresis Mode) Lower Switch Point FL1 (Window Mode)	25 % Measuring Range	RP1 < SP1 FL1 < FH1 Hysteresis ≥ 1 % FS	RP1
Switch Point SP2 (Hysteresis Mode) Upper Switch Point FH2 (Window Mode)	75 % Measuring Range	SP2 > RP2 FH2 > FL2 Hysteresis ≥ 1 % FS	SP2
Reset Point RP2 (Hysteresis Mode) Lower Switch Point FL2 (Window Mode)	25 % Measuring Range	RP2 < SP2 FL2 < FH2 Hysteresis ≥ 1 % FS	RP2
Switch Point Delay Time SP1 (Hysteresis Mode) Switch Point Delay Time FH1 (Window Mode)	0	0 ... 99.99 s	dS1
Switch Point Delay Time RP1 (Hysteresis Mode) Switch Point Delay Time FL1 (Window Mode)	0	0 ... 99.99 s	dR1
Switch Point Delay Time SP2 (Hysteresis Mode) Switch Point Delay Time FH2 (Window Mode)	0	0 ... 99.99 s	dS2
Switch Point Delay Time RP2 (Hysteresis Mode) Switch Point Delay Time FL2 (Window Mode)	0	0 ... 99.99 s	dR2
Functions Switching Output 1	Hysteresis, N/O (Hno)	Hysteresis NO (Hno), Hysteresis NC (Hnc), Window NO (Fno), Window NC (Fnc)	ou1
Functions Switching Output 2	Hysteresis, N/O (Hno)	Hysteresis NO (Hno), Hysteresis NC (Hnc) Window NO (Fno), Window NC (Fnc)	ou2
Pressure Units	psi	psi, bar, MPa, kPa, m WC	uni
Measuring Range Adjustment	100 % Nominal Pressure	50 ... 100 % Nominal	P-EP
Damping (Analog Output)	0.01 s	0.01 ... 3.00 s (Time Constant)	dAA
Display Rotation	No	No, Yes (180°)	disr
Display Mode	Current Pressure Value	Pressure Value: Current, Highest, Lowest, Display Off Current Value: Decimal Places Selectable (Max. 3)	dis
Display Update	2	1, 2, 5, 20 Hz	duPd

Dimensions (mm)

PSD

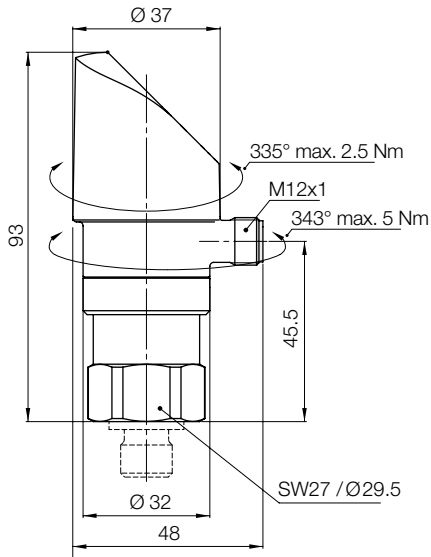

PSD-...N2...

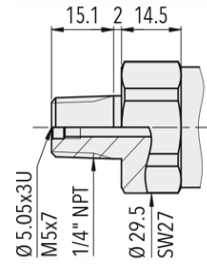

Electrical Connection

Protection/Electrical Connection	
IP65	
M12x1	
5-pole	
Pin Assignment	
	Us+ = 1 Us- = 3 Output = 2 SP1 = 4 SP2 = 5
	Shield

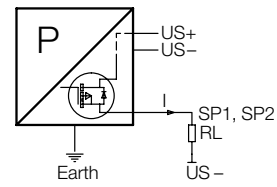
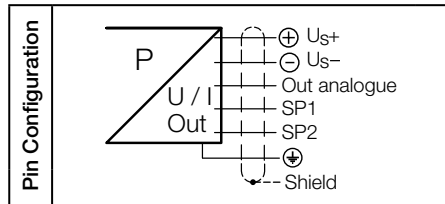

Connection of loads to switching output

Functions Switching Output

Hysteresis

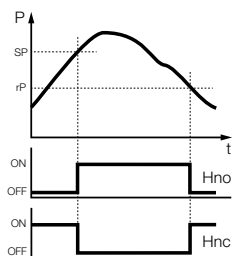

Window

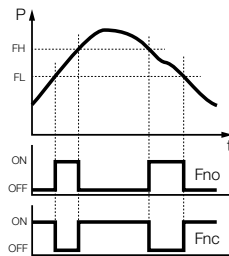

Delay

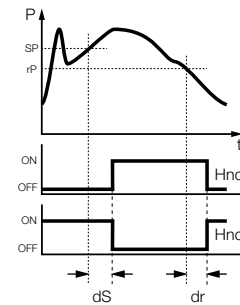

Terminology References

BSL: Best Straight Line

The reference line according to the BSL or the minimum value adjustment is placed in such a way that the maximum positive and negative deviations are as small as possible.

Specifications: Accuracy NLH (BSL)

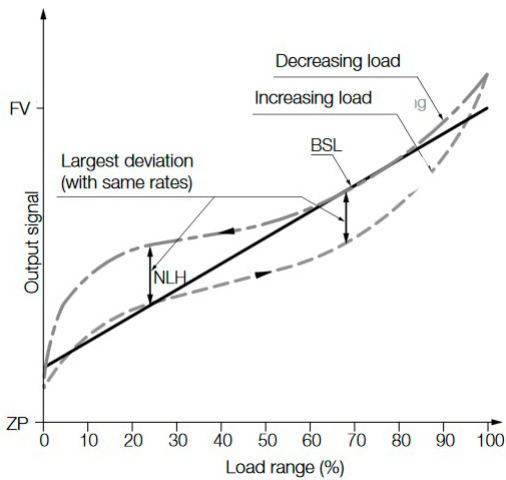

Long-term Stability and Long-term Drift

The change of accuracy due to aging under certain reference conditions during a period of time, typically one year.

Non-linearity

The largest deviation from the effective characteristic line of an ideal reference line. The reference line can be defined as a limit point adjustment, a BSL, or a BSL through 0.

Specifications: Non-linearity, Hysteresis

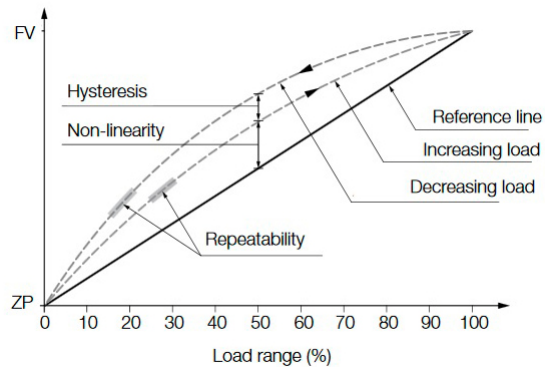

BSL/0: Best Straight Line through Zero

As an additional requirement for the minimum value adjustment, the BSL through zero (also BSL/0) must go straight through zero or the origin.

Specifications: Accuracy NLH (BSL through Zero)

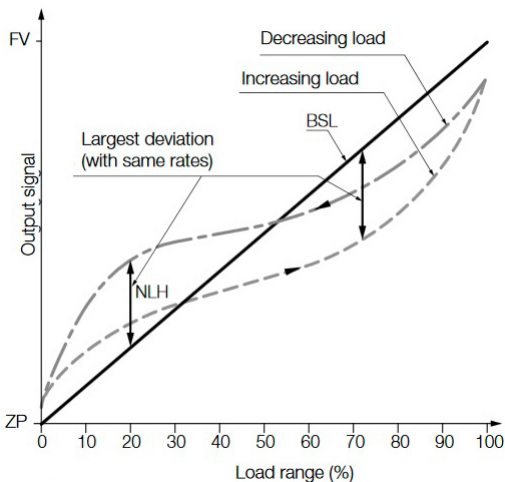

NLH: Non-linearity and Hysteresis

Largest deviation from the ideal characteristic line (BSL, BSL/0 or limit point). In pressure measuring instruments, the non-linearity and pressure hysteresis are given together at a constant temperature.

TEB: Total Error Band

Total error (root from sum of the square of the deviations) due to measurement deviations (accuracy) and temperature influence (temperature coefficient TC). The temperature influence is usually given in the information across a range larger than that given in the standard (-10...60 °C).

TC: Temperature Coefficient

Change of measured value for zero point and span as a result of changes in temperature.