

# Kobold ACM-1

Transmitter/controller for conductivity, TDS, resistance, temperature and standard signals



Operating instructions

**WARNING:**

A sudden malfunction of the instrument, or one of the sensors connected to it, could potentially result in dangerous overdosing! Suitable preventive measures must be in place to prevent this from happening.

---



**Note:**

Please read these Operating Instructions before placing the instrument in operation. Keep the manual in a place which is accessible to all users at all times.





---

**Resetting the brightness of the LC display:**

If the brightness setting has been adjusted so that the display text is no longer legible, the basic setting can be restored as follows:

- \* Switch off the supply voltage.
- \* Switch on the supply voltage and immediately press and hold the  and  keys simultaneously.

**Operator language selection:**

- \* Press the  key for longer than 3 seconds.
  - \* Select the appropriate language with the  and  keys.
  - \* Briefly press the  key.
-

# Contents

---

<b>1</b>	<b>Typographical conventions</b> .....	<b>7</b>
1.1	Warning signs .....	7
1.2	Reference signs .....	7
<b>2</b>	<b>Description</b> .....	<b>8</b>
<b>3</b>	<b>Instrument identification</b> .....	<b>10</b>
3.1	Nameplate .....	10
3.2	Type designation .....	10
3.3	Accessories (included in delivery) .....	12
3.4	Accessories (optional) .....	12
<b>4</b>	<b>Mounting</b> .....	<b>13</b>
4.1	General information .....	13
4.2	Dimensions .....	13
<b>5</b>	<b>Installation</b> .....	<b>14</b>
5.1	Installation instructions .....	14
5.2	Electrical isolation .....	15
5.3	Connection .....	16
<b>6</b>	<b>Operation</b> .....	<b>20</b>
6.1	Controls .....	20
6.2	Display .....	21
6.3	Principle of operation .....	22
6.4	Measuring mode .....	25
6.5	Input/output information .....	26
6.6	User level .....	31
6.7	Administrator level .....	32
6.8	MANUAL mode / Simulation mode .....	35
6.9	HOLD mode .....	38
<b>7</b>	<b>Commissioning</b> .....	<b>40</b>
7.1	Getting started .....	40
7.2	Setting examples .....	41
<b>8</b>	<b>Calibrating a conductivity cell</b> .....	<b>47</b>
8.1	Notes .....	47
8.2	General information .....	47
8.3	Calibration of the temperature coefficient of the sample medium .....	48
8.4	Calibrating the relative cell constant .....	51

---

# Contents

---

<b>9</b>	<b>Calibrating a sensor with a standard signal .....</b>	<b>53</b>
9.1	General information .....	53
9.2	Linear operating mode .....	55
9.3	pH operating mode .....	59
9.4	Conductivity operating mode .....	63
9.5	Concentration operating mode .....	69
9.6	Chlorine measurement operating mode, pH-compensated 71	
<b>10</b>	<b>Calibration logbook .....</b>	<b>73</b>
10.1	General information .....	73
<b>11</b>	<b>Controller .....</b>	<b>74</b>
11.1	General information .....	74
11.2	Controller functions .....	74
11.3	Software controllers and outputs .....	75
11.4	Configuration of higher order controllers .....	77
11.5	Parameter sets .....	77
11.6	Sample configurations .....	78
<b>12</b>	<b>Setup program .....</b>	<b>80</b>
12.1	Configurable parameters .....	80
12.2	Documenting the instrument configuration .....	81
12.3	Special features for "Datalogger" .....	82
<b>13</b>	<b>Eliminating faults and malfunctions .....</b>	<b>84</b>
<b>14</b>	<b>Technical data .....</b>	<b>86</b>
14.1	Approvals/marks of conformity .....	88
<b>15</b>	<b>Retrofitting optional boards .....</b>	<b>89</b>
15.1	Identifying an optional board .....	89
15.2	Removing a plug-in module .....	91
15.3	Inserting a plug-in module .....	91
15.4	Retrofitting optional boards (field housing) .....	92
<b>16</b>	<b>Appendix .....</b>	<b>94</b>
16.1	Glossary .....	94
16.2	Parameters of the User level .....	106
<b>17</b>	<b>Disposal.....</b>	<b>118</b>
<b>18</b>	<b>EU Declaration of Conformance.....</b>	<b>119</b>
<b>19</b>	<b>UK Declaration of Conformance.....</b>	<b>120</b>

---

---

## Index

1-point calibration - pH 59  
2-point calibration 97  
2-point calibration - pH 61

### A

Accessories 12  
Administrator 32

### B

Basic setting 32  
Binary inputs and outputs  
States 29

### C

Calibration  
Logbook 73  
pH, 2-point 61  
Standard signal 53  
Standard signal, options 54  
Calibration release 35  
Cell constant 51–52  
Configurable parameters 80  
Controller  
"Higher order" switching functions 74  
"Simple" switching functions 74  
Configuration of "higher order" controllers  
77  
General information 74  
Parameter sets 77  
Setting example, limit monitoring 78  
Controller functions 74  
Customer settings 106

### D

Datalogger  
Special features 82  
Date of manufacture 10  
Delete 35  
Display 21

### E

Electrical isolation 15

### F

Factory settings 106

### G

Getting started 40

### H

HOLD mode 38

### I

Info  
Hardware 30  
Instrument 31  
Installation position 13

### K

Key combinations 26

### L

Language selection 2  
Limit functions 99

### M

Manual 30  
MANUAL mode 35  
Analog outputs 37  
Binary outputs 37  
Controller 36  
Deactivation 39  
Switching outputs 36  
Manual mode overview 30  
Menu  
Customer specs. 27  
Min/max values 27–28  
Mounting location 13

### O

Optional inputs  
Current values 29  
Output 28  
Output display 28

### P

Parameter overview 106  
Password 32  
Ph. Eur. 102  
Principle 22  
Principle of operation 26  
Purified water 102

### R

Rapid access 26  
Reference signs 7  
Reset display brightness 2

### S

Setting the operator language 2  
Setup program 80

---

Simulation mode 35  
Simulation of binary outputs 37  
States 29  
Sunlight 13

## **T**

TDS measurement 102  
Temperature compensation 97–98

## **U**

Ultra-pure water 101  
User 31  
User data 27  
USP 101

## **W**

Warning signs 7  
Wash timer 100  
Washing contact 100

## **Z**

Zero point calibration 97



---

The instruction manuals on our website [www.kobold.com](http://www.kobold.com) are always for currently manufactured version of our products. Due to technical changes, the instruction manuals available online may not always correspond to the product version you have purchased. If you need an instruction manual that corresponds to the purchased product version, you can request it from us free of charge by email ([info.de@kobold.com](mailto:info.de@kobold.com)) in PDF format, specifying the relevant invoice number and serial number. If you wish, the operating instructions can also be sent to you by post in paper form against an applicable postage fee.

---

# 1 Typographical conventions

---

## 1.1 Warning signs



---

### Danger

This symbol is used when there may be **danger to personnel** if the instructions are ignored or not followed correctly!



---

### Caution

This symbol is used when there may be **damage to equipment or data** if the instructions are ignored or not followed correctly!

---

## 1.2 Reference signs



---

### Note

This symbol is used to draw your **special attention** to a remark.

abc<sup>1</sup>

---

### Footnote

Footnotes are remarks that **refer to specific points** in the text. Footnotes consist of two parts:

A marker in the text and the footnote text.

The markers in the text are arranged as consecutive superscript numbers.

\*

---

### Instruction

This symbol indicates the description of an **action to be performed**.

The individual steps are marked by this asterisk.

Example:

\* Briefly press the  key.

---

## 2 Description

---

**Inputs/outputs** In addition to the main input (conductivity, TDS, resistance) and the secondary input (temperature compensation), the basic instrument alone has two binary inputs, two relays, one power supply for external sensors and a setup interface.

Input signals can be shown as numbers or as a bar graph on the graphic display. Parameters are displayed in plain text for easily comprehensible and reliable operation.

**Optional** Three further slots can be fitted with extensive additional configurable inputs and outputs and interfaces.

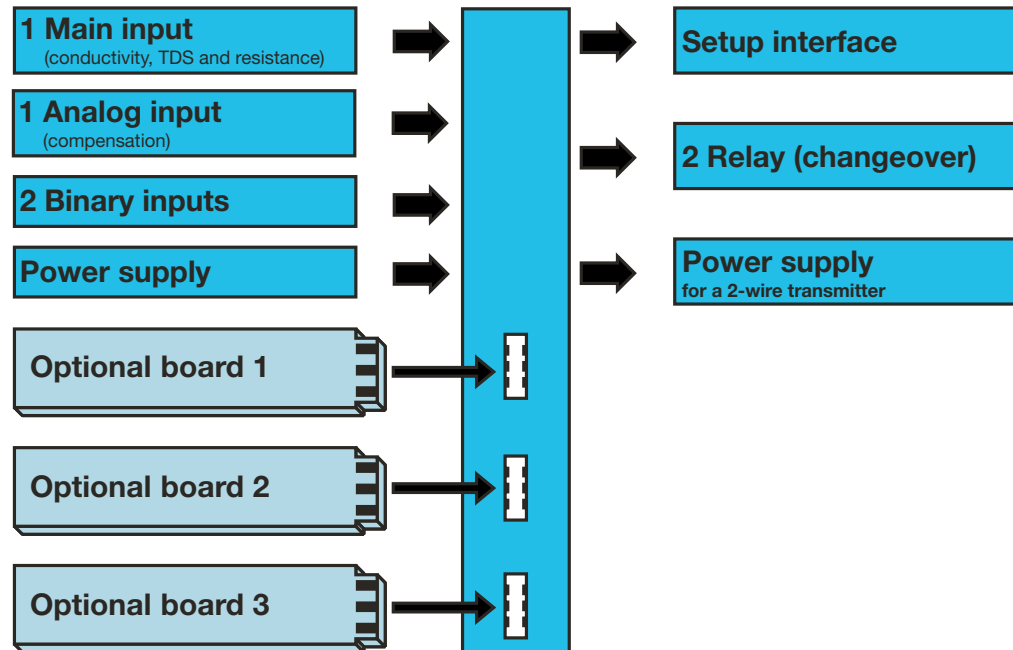

**Application** The instrument is suitable, for example, for displaying, measuring and controlling:

- Conductivity, TDS and resistance.
- Free chlorine, chlorine dioxide, ozone, hydrogen peroxide and peracetic acid, in combination with suitable sensors.
- (Hydrostatic) liquid levels with 2-wire transmitters (level probes)
- Flow rate in conjunction with transmitters
- Two temperature measuring points.
- Most sensors and transmitters that output standard signals (0 - 10 V or 0(4) - 20 mA).

Because temperature measurement is integrated, temperature compensation takes place quickly and precisely, which is particularly important for many analytical measurements.

**Special features**

- Display: mS/cm,  $\mu$ S/cm, MOhm x cm, mg/l, pH, mV, etc. Special settings are also possible with the setup program
- Configurable display text (operator level)
- A choice of display visualizations: large numbers, bar graph or tendency



## 2 Description

---

- (trend) display
- Four limit controllers
- Integrated calibration routines: with 1, 2 and 3 points
- Math and logic module (optional)
- Calibration logbook
- Three optional slots
- Selectable languages: English, German, French, etc.
- Setup program provides: convenient programming, system documentation
- RS422/485 interface (optional)
- Profibus-DP interface (optional)

# 3 Instrument identification

---

## 3.1 Nameplate

on the transmitter

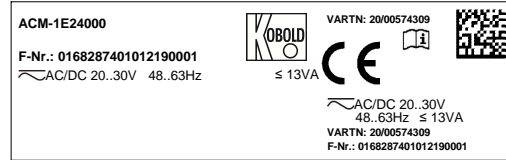

	<p>The date of manufacture is encoded in the "F No." (serial number): 1122 means year of manufacture 2011 / calendar week 22</p>
---	--

# 3 Instrument identification

## 3.2 Type designation

Order Details (Example: ACM-1 E 1 0 0 0 Y)

Model	Version	Housing	Power supply	Option 1 (Optional board)	Option 2 (Optional board)	Option 3 (Optional board)	Special
<b>ACM</b> Evaluation electronics conductivity/specific resistance/TDS	<b>1</b> = Compact-Line (new) Input: 1x conductivity/specific resistance/TDS 1x temperature/standard signal, 2x binary input sensor supply: 2-wire transmitter, 2 relays	<b>E</b> = for panel mounting <b>F</b> = Field housing <b>S</b> = Field housing with wall mounting bracket <b>R</b> = Field housing with pipe mounting bracket	<b>1</b> = 110...240 V <sub>AC</sub> -15%/+10%, 48...63 Hz <b>2</b> = 20...30 V <sub>AC/DC</sub> , 48...63 Hz	<b>4</b> = analogue output 0(4)-20 mA, 0(2)-10V <b>(Standard)</b> <b>0</b> = without <b>1</b> = universal input (Pt100, Pt1000, resistance, current, voltage) <b>2</b> = 1 relay (changeover contact) <b>3</b> = 2 relays < (NO with common pin) <b>4</b> = analogue output 0(4)-20 mA, 0(2)-10V <b>5</b> = 2 Photo-Mos relay switch (0.2A) <b>6</b> = 1 semiconductor relay TRIAC (1A) <b>7</b> = 1 power supply 4.85V (e. g. for ISFET sensor) <b>8</b> = 1 power supply 12V <sub>DC</sub> (e. g. for inductive proximity switch)	<b>0</b> = without <b>1</b> = universal input (Pt100, Pt1000, resistance, current, voltage) <b>2</b> = 1 relay (changeover contact) <b>4</b> = analogue output 0(4)-20 mA, 0(2)-10V <b>5</b> = 2 Photo-Mos relay switch (0.2 A) <b>6</b> = 1 semiconductor relay TRIAC (1A) <b>7</b> = 1 power supply 4.85V (e. g. for ISFET sensor) <b>8</b> = 1 power supply 12 V <sub>DC</sub> (e. g. for inductive proximity switch)	<b>0</b> = without <b>1</b> = universal input (Pt100, Pt1000, resistance, current, voltage) <b>2</b> = 1 relay (changeover contact) <b>3</b> = 2 Relais (NO with common pin) <b>4</b> = analogue output 0(4)-20 mA, 0(2)-10 V <b>5</b> = 2 Photo-Mos relay switch (0.2 A) <b>6</b> = 1 semiconductor relay TRIAC (1A) <b>7</b> = 1 power supply 4.85 V (e. g. for ISFET sensor) <b>8</b> = 1 power supply 12 V <sub>DC</sub> (e. g. for inductive proximity switch) <b>S</b> = Interface RS 422/485 <b>D</b> = Data logger with interface RS 485 <sup>1)</sup> <b>P</b> = Interface Profibus DP	<b>0</b> = without (factory set) <b>Y</b> = adjusted according to customer specification

<sup>1)</sup> The readout of data is only possible with the PC setup software! Note: All languages are available on the device side and can be changes by the customer at any time. The factory default setting of a language (except for "German") entail additional costs.

## 3 Instrument identification

---

### 3.3 Accessories (included in delivery)

- 4 x fastening elements, complete<sup>1</sup>
- 3 x CON plug-in link<sup>1</sup>
- 3 x jumper wire<sup>2</sup>
- 1 x seal for panel<sup>1</sup>
- 1 x fastening elements, complete<sup>2</sup>
  - 1 x DIN rail fastening left
  - 1 x DIN rail fastening right
  - 3 x wall mount
  - 3 x fastening screw

<sup>1</sup> For basic type extension 01 only (in the panel enclosure)

<sup>2</sup> For basic type extension 05 only (in the surface-mounted enclosure)

### 3.4 Accessories (optional)

Type	Sales No.
Holder for C rail	ACM-Halt
PC setup software	ACM-Soft
PC interface cable including USB/TTL converter and two adapters (USB connecting cable)	ACM-Int

Optional board	Code	Sales No.
Analog input (universal)	1	APM-1000001
Relay (1 x changeover)	2	APM-1000002
Relay (2 x NO)	3	APM-1000003
Analog output	4	APM-1000004
Two MosFET semiconductor switches	5	APM-1000005
Semiconductor relay 1 A	6	APM-1000006
Supply voltage output +/- 5 V DC (e.g. for ISFET)	7	APM-1000007
Supply voltage output 12 V DC (e.g. for inductive proximity switch)	8	APM-1000008
Interface - RS422/485	10	APM-100000S
Datalogger with RS485 interface	11	APM-100000D
Profibus-DP interface	12	APM-100000P

## 4.1 General

### Mounting location

Find a location that ensures easy accessibility for the later calibration.  
The fastening must be secure and must ensure low vibration for the instrument.

Avoid direct sunlight!

Permissible ambient temperature at the installation location: -10 - 55°C with max. 95% rel. humidity, no condensation.

### Installation position

The instrument can be mounted in any position.

## 4.2 Dimensions

### 4.2.1 Panel mounting

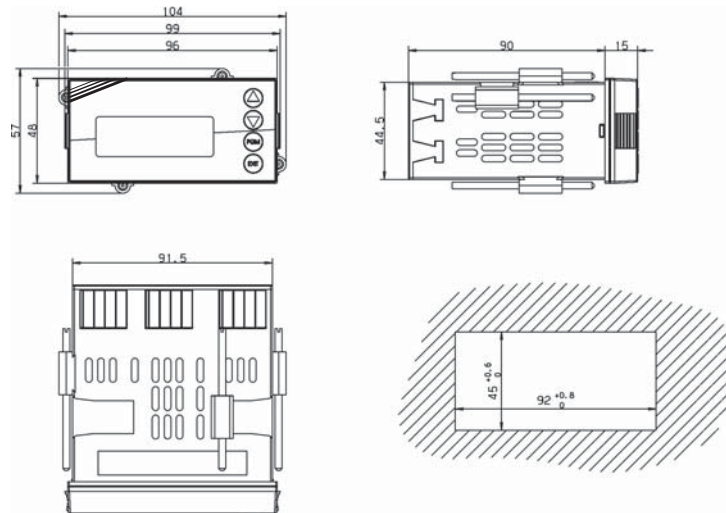

### Close mounting

Minimum spacing of panel cutouts	Horizontal	Vertical
Without setup connector:	30mm	11mm
With setup connector (see arrow):	65mm	11mm

### 4.2.2 Field housing

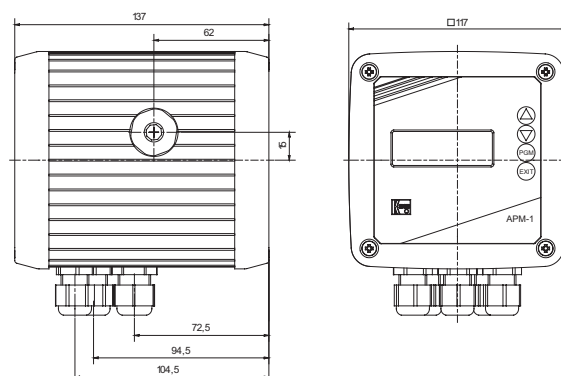

# 5 Installation

---

## 5.1 Installation instructions



**The electrical connection must only be performed by qualified personnel!**

- The choice of cable, the installation and the electrical connection must conform to the requirements of VDE 0100 “Regulations on the Installation of Power Circuits with Nominal Voltages below 1000 V” and the relevant local regulations
- If contact with live parts is possible when working on the device, it must be completely disconnected from the electrical supply.
- The load circuits must be fused for the maximum load currents in each case to prevent the relay contacts from becoming welded in the event of a short circuit.
- Electromagnetic compatibility meets the requirements of EN 61326.
- Lay the input, output, and supply lines so they are physically separated from each other and are not parallel.
- Use twisted and shielded probe cables. If possible, do not lay these cables close to components or cables through which current is flowing. Ground the shielding at one end.
- The probe cables must have an uninterrupted run (do not route them via terminal blocks or similar arrangements).
- No other consumers can be connected to the power terminals of the instrument.
- The instrument is not suitable for installation in areas with an explosion hazard.
- Apart from faulty installation, incorrect settings on the instrument may also affect the proper functioning of the subsequent process or lead to damage. You should therefore always provide safety equipment that is independent of the instrument and it should only be possible for qualified personnel to make settings.

### Mounting information for conductor cross-sections and ferrules

Ferrule	Conductor cross-section		Minimum length of ferrule or stripping
	Minimum	Maximum	
Without ferrule	0.34 mm <sup>2</sup> .	2.5 mm <sup>2</sup> .	10mm (stripping)
Without collar	0.25 mm	2.5 mm <sup>2</sup> .	10mm
With collar up to 1.5 mm <sup>2</sup>	0.25 mm <sup>2</sup> .	1.5 mm <sup>2</sup> .	10mm
Twin, with collar	0.25 mm <sup>2</sup> .	1.5 mm <sup>2</sup> .	12mm

## 5.2 Electrical isolation

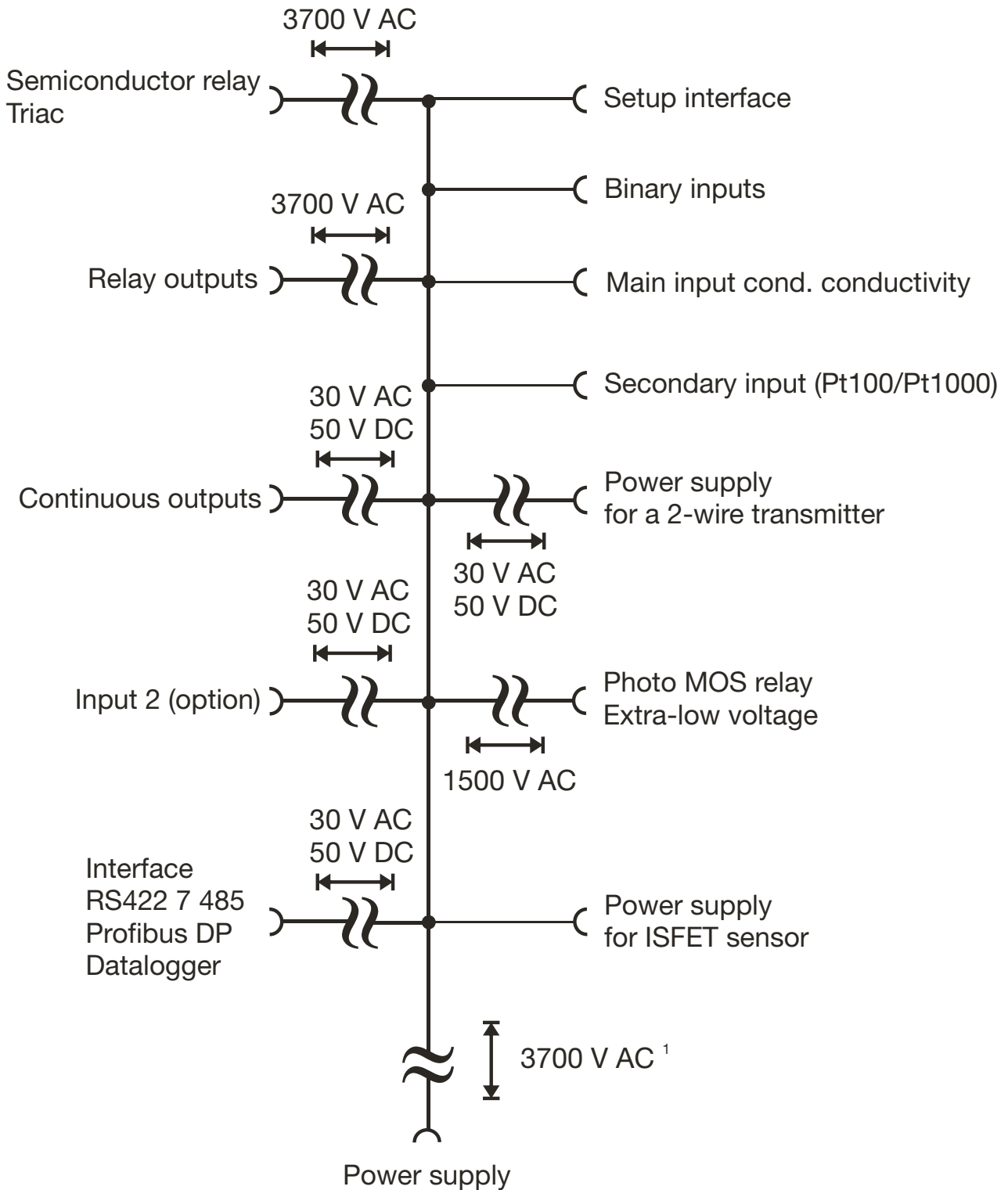

# 5 Installation

## 5.3 Connection

### 5.3.1 Terminal assignment

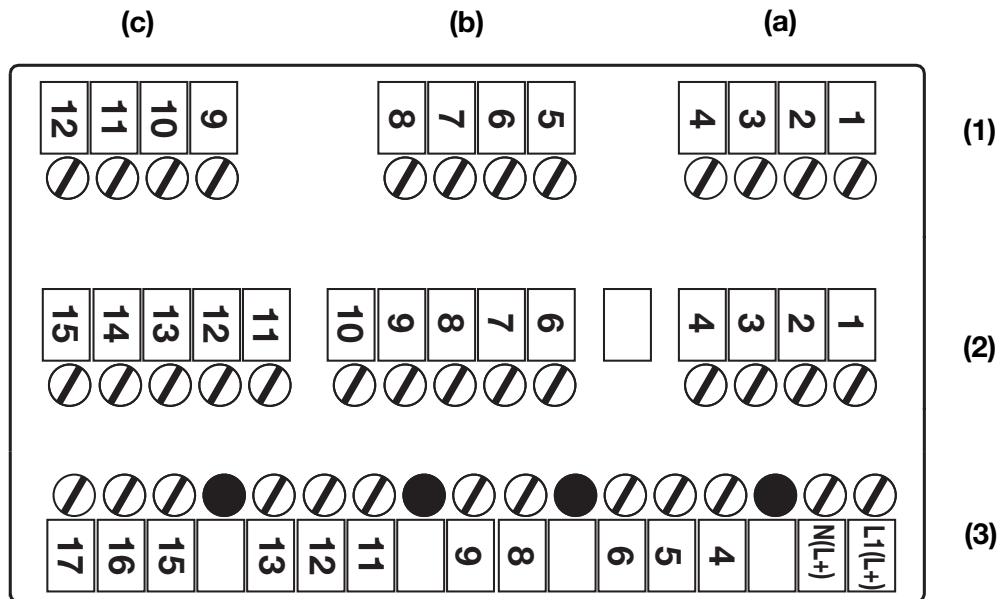

(1)	Row 1	(a)	Option 1	(b)	Option 2	(c)	Option 3	
(2)	Row 2	Main input board (conductivity / resistance / temperature / standard signal)						
(3)	Row 3	PSU board (power supply / 2x relays)						

### 5.3.2 Optional board (row 1, slot a, b or c)

Function	Symbol	Terminal for slot (a)	Terminal for slot (b)	Terminal for slot (c)
<b>Analog input</b>				
<b>Temperature sensor in a two-wire circuit</b> Pt100 or Pt1000		2	6	10
		4	8	12
<b>Temperature sensor in a three-wire circuit</b> Pt100 or Pt1000		2	6	10
		3	7	11
		4	8	12
<b>Resistance transmitter</b>		2	6	10
		3	7	11
		4	8	12
		E		
		S		
		A		
<b>Electrical current</b>		3	7	11
		4	8	12





## 5 Installation

Function	Symbol	Terminal for slot (a)	Terminal for slot (b)	Terminal for slot (c)
<b>Voltage</b> 0(2) - 10 V		1	5	9
		2	6	10
<b>Voltage</b> 0 - 1 V		2	6	10
		3	7	11
<b>Continuous output</b>				
<b>Current or voltage</b>		2	6	10
		3	7	11
<b>Modbus interface</b>				
RS422		1	5	9
		2	6	10
		3	7	11
		4	8	12
RS485		3	7	11
		4	8	12
<b>Profibus interface</b>				
		1	5	9
		2	6	10
		3	7	11
		4	8	12
<b>Datalogger interface</b>				
RS485		2	6	10
		3	7	11
<b>Relay (1x changeover)</b>				
		K3 1	K4 5	K5 9
		2	6	10
		3	7	11
<b>Relay (2x NO, common pin)</b>				
		K3 1		K5 9
		2		10
		K6 3		K8 11
<b>Triac (1 A)</b>				
		K3 2	K4 6	K5 10
		3	7	11
<b>Photo MOS relay (0.2 A)</b>				
		K3 1	K4 5	K5 9
		2	6	10
		K6 3	K7 7	K8 11
		4	8	12

# 5 Installation

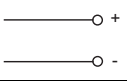
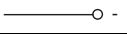
## 5.3.3 Main board (row 2)

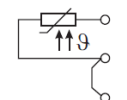
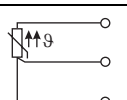
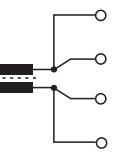
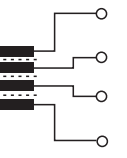
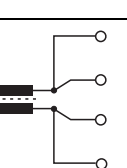
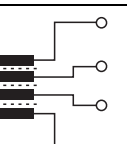
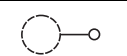
Function	Symbol	Terminal
<b>Standard signal input for electrical current</b> 0(4) - 20 mA		3 4
<b>Standard signal input for voltage</b> 0(2) - 10 V or 10 - 0(2) V		1 4
<b>Temperature sensor in a two-wire circuit</b> Pt100 or Pt1000		2 3 4
<b>Temperature sensor in a three-wire circuit</b> Pt100 or Pt1000		2 3 4
<b>Resistance transmitter</b>		4 3 2
<b>Conductivity cell</b>		
Conductivity cell (2-electrode system) Terminals 6+7 and 8+9 can be bridged on the instrument; 2-wire cable routing up to the head of the conductivity cell. For concentric cells, terminal 6 must be connected with the outer electrode.		6 7 8 9
Conductivity cell (2-electrode system) Wiring for highest accuracy; 4-wire cable routing to the head of the conductivity cell. For concentric cells, terminal 6 must be connected with the outer electrode.		6 7 8 9
Conductivity cell (4-electrode system) 6 - Outer electrode 1 7 - Inner electrode 1 8 - Inner electrode 2 9 - Outer electrode 2		6 7 8 9
<b>Shield connection</b>		
Conductivity cell		10 GND
<b>Binary inputs</b>		
Binary input 1		12+ 14
Binary input 2		13+ 14

## 5 Installation

### 5.3.4 PSU board (row 3)

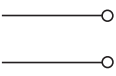
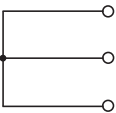
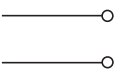
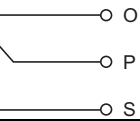
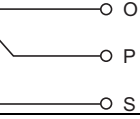
Function	Symbol	Terminal
<b>Power supply for ACM-1</b>		
Power supply: AC 110 - 240 V		1 L1 (L+) 2 N (L-)
Power supply: AC/DC 20 - 30 V		
n.c.		4 5 6
<b>Supply voltage for external 2-wire transmitter</b>		
24 V DC (-15 / +20%)		8 L+ 9 L-
<b>Relay 1</b>		
Switching output K1 (floating)		11 12 13
<b>Relay 2</b>		
Switching output K2 (floating)		15 16 17

## 6 Operation

---



Operation via the instrument keypad is described below.

Instrument operation via the optional set-up program, See section 12 "Setup program", page 80.

---

### 6.1 Controls

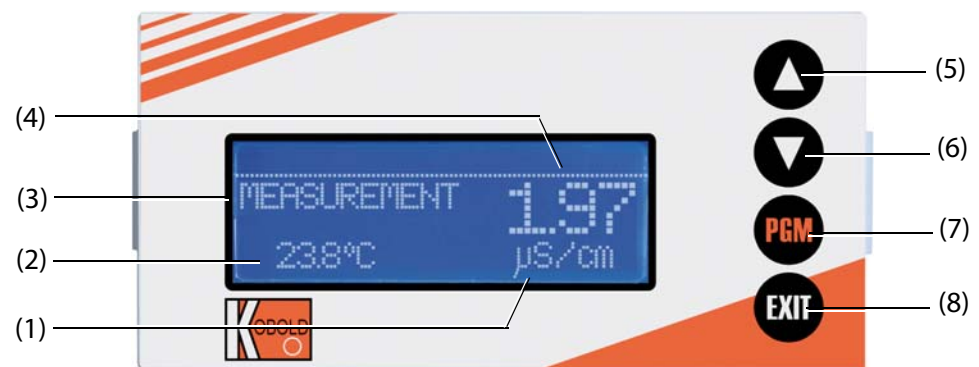

- (1) Measurement unit
- (2) Temperature
- (3) Operating mode
- (4) Measured value
- (5) ▲ key      Increase numerical value / Forward selection
- (6) ▼ key      Decrease numerical value / Forward selection
- (7) PGM key    Change level / Forward selection / Confirm selection
- (8) EXIT key    Cancel entry / Exit level

### 6.2 Display

#### 6.2.1 Measuring mode (normal display)

##### Example

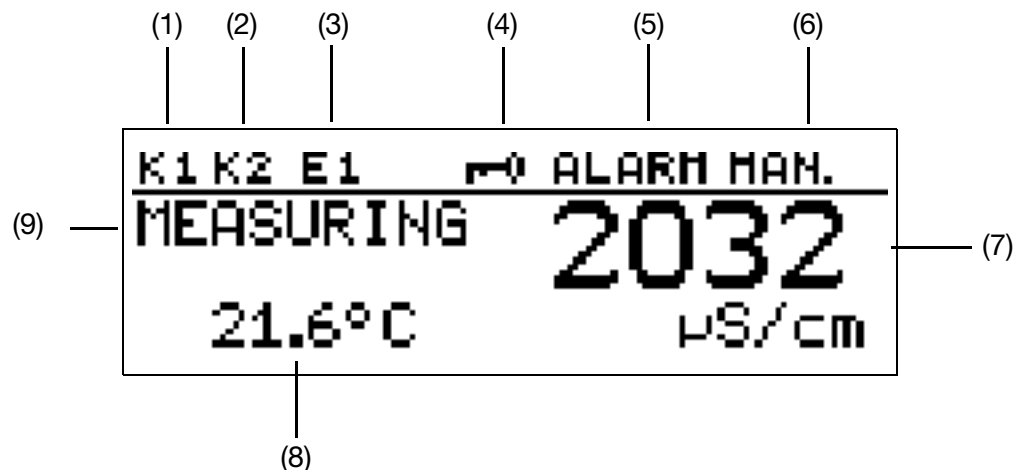

- (1) Binary output (relay) K1 is active
- (2) Binary output (relay) K2 is active
- (3) Binary input is active
- (4) Keypad is locked
- (5) Instrument status
  - ALARM (flashing): Broken sensor or overrange, etc.
  - AL R1: Controller monitoring alarm from controller channel 1
  - AL R2: Controller monitoring alarm from controller channel 2
  - CALIB: Calibration mode active
  - CALIB (flashing): Calibration timer elapsed
- (6) Output mode
  - MAN.: Manual mode and/or simulation mode active
  - HOLD: Hold mode active
- (7) Top display
  - Measured value and unit of the variable set by parameter "Top display"
- (8) Bottom display
  - Measured value and unit of the variable set by parameter "Bottom display"
- (9) Operating mode
  - MEASURING: Standard measuring mode is active



To return to Measuring mode (MEASURING):  
Press the  key or wait for a "timeout".

# 6 Operation

---

## 6.3 Principle of operation

### 6.3.1 Operation in levels

See page

#### Measurement mode

Normal display	25
Min/max values of the main input	27
Min/max values of the optional inputs	28
Output display	28
Current values of the main input	28
Current values of the optional inputs	29
Current values of the math channels	29
States of the binary inputs and outputs	29
Manual mode overview	30
Hardware information	30
Instrument information	31
User data	81
Calibration (depending on the basic setting)	47, 53
Manual mode / simulation	35
Hold mode	38

#### Main menu

User level	31
Conductivity input	106
Temperature input	107
Optional inputs	107
Analog input 1, 2, 3	
Binary inputs	109
Binary input 1, 2	
Controllers	109
Controller 1	
Parameter set 1, 2	
Configuration	
Controller 2	
Parameter set 1, 2	
Configuration	
Controller special functions	111
Limit value control	111
Limit value 1, 2, 3	
Binary outputs	112
Binary output 1, 2, 3, ... 8	
Analog outputs	113
Analog output 1, 2, 3	
Interface	114
Wash timer	115
Datalogger	115

## 6 Operation

Display	115
Administrator level (password)	32
Parameter level	32
Parameters as above for "User level"	
Release level	32
Parameters as above for "User level"	
Basic setting	32
Calibration level	35
Main input (depending on the basic setting)	
Temperature coefficient, linear	
Relative cell constant	
Optional input 1, 2, 3	
Temperature coefficient, linear	
Temperature coefficient, curve	
Relative cell constant	
Zero point	
Limit point	
2-point	
Calibration release	35
Main input (depending on the basic setting)	
Temperature coefficient, linear	
Temperature coefficient, curve	
Relative cell constant	
Zero point	
Limit point	
2-point	
3-point	
K factor	
Optional input 1, 2, 3	
Temperature coefficient, linear	
Temperature coefficient, curve	
Relative cell constant	
Zero point	
Limit point	
2-point	
3-point	
Delete min/max values	35
Main input	
Optional input 1, 2, 3	
Delete logbook	35
Main input	
Optional input 1, 2, 3	
Delete daily batch	35
Delete total batch	35

# 6 Operation

---

Calibration level	47
Main input	
Temperature coefficient, linear	
Temperature coefficient, curve	
Optional input 1, 2, 3	107
Temperature coefficient, linear	
Temperature coefficient, curve	
Relative cell constant	
Zero point	
Limit point	
2-point	
Calibration logbook	73
Main input	
Optional input 1, 2, 3	
Instrument information	31



### 6.4 Measuring mode

---



Different display types can be configured, See "Display of measured values STANDARD" page 94.

To return to Measuring mode:  
press the **EXIT** key or wait for a "timeout".

Measurements with "out of range" are ignored.

The min./max. value memory can be reset:  
Administrator level / Delete min/max.

When the basic setting is changed, the min and max values are deleted.

---

#### 6.4.1 Normal display

##### Visualization

The following are displayed in Measuring mode:

- Analog input signal
- Unit (for example pH)
- Temperature of the sample medium

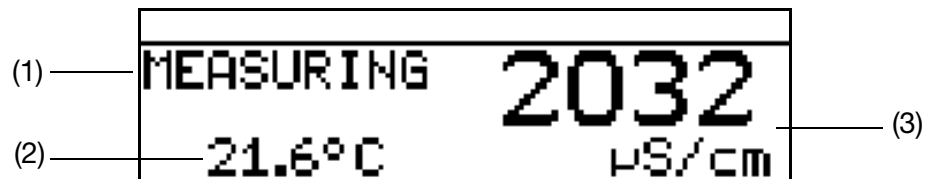

- (1) MEASURING -> Measuring mode
- (2) 21.6°C -> Temperature of the sample medium
- (3) 2032 µS/cm -> the measured value calculated from the standard signal at the input

# 6 Operation

## 6.5 Input/output information

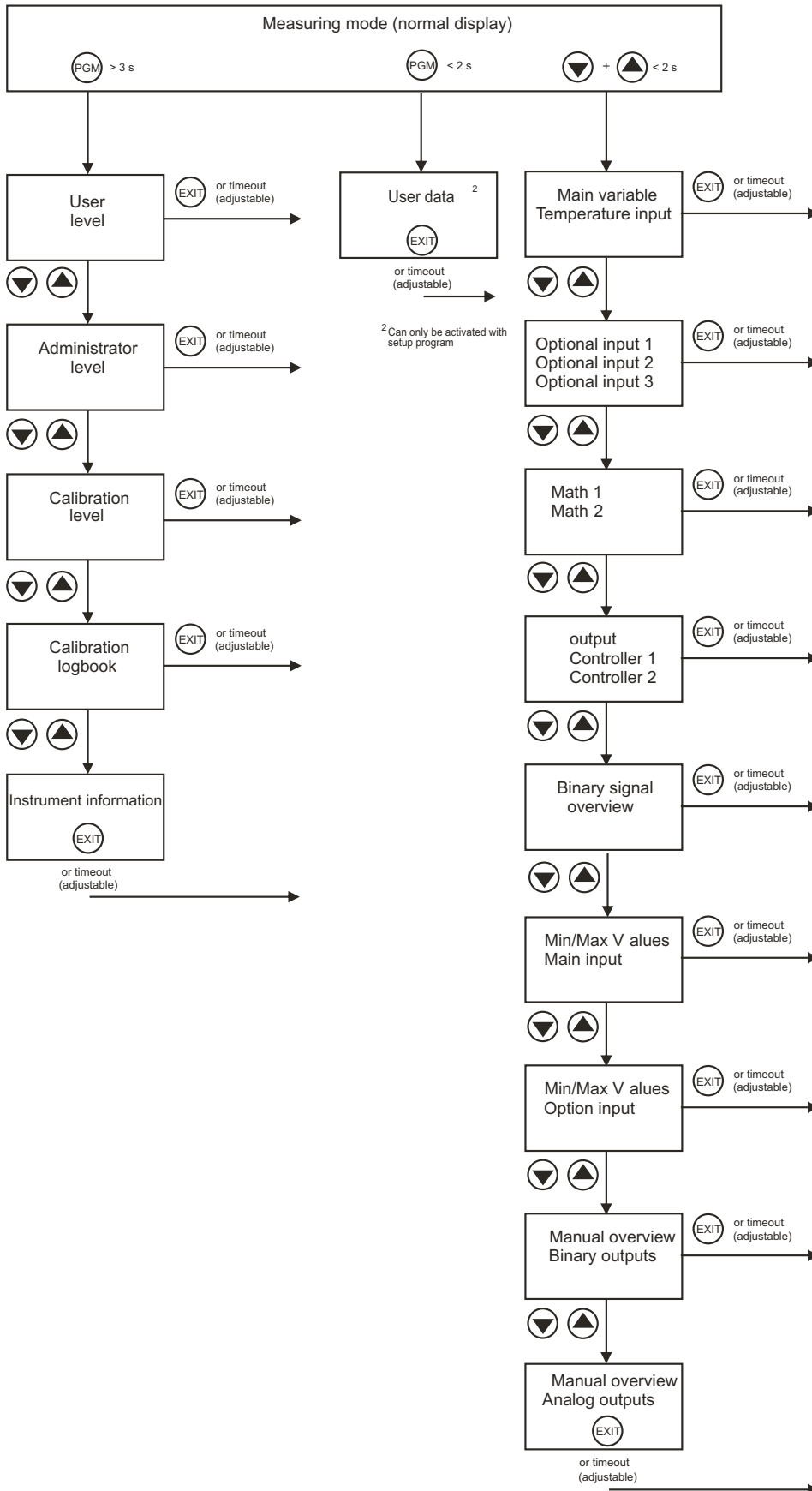

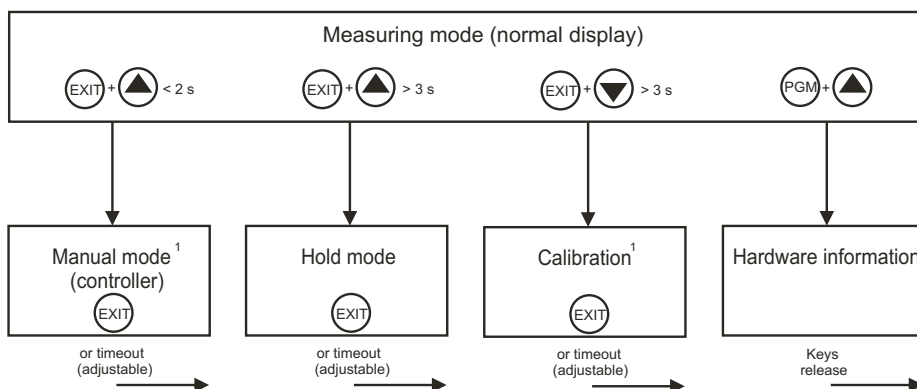

<sup>1</sup> Only if released

### 6.5.1 User data

```

SP 1 Reservoir II
817 µS/cm
    
```

Up to 8 parameters that are frequently changed by the user can be combined in the user level under "User data" (via setup program only).

#### Activating the display

The instrument is in Measuring mode (normal display)

- \* Briefly press the **PGM** key.
- \* Select the required "quick setting" with the **▲** and **▼** keys.

#### Editing

- \* Briefly press the **PGM** key.
- \* Edit the setting with the **▲** and **▼** keys.

### 6.5.2 Min/max values of the main input

```

MIN/MAX MAIN INP.
1:      813      818 µS/cm
2:      0.81     0.81 mS/cm
T:      24.3     74.5 °C
    
```

#### Activating the display

The instrument is in Measuring mode (normal display)

- \* Briefly press the **▲** or **▼** key (several times if necessary).  
Minimum and maximum values of the main value "1:" (mS/cm, µS/cm,

## 6 Operation

---

MOhm x cm, mV, %, ppm) and the temperature "T:" are displayed.

The extreme values of the main measurement variable and the temperature are **not** mutually assigned (e.g. not 813  $\mu\text{S}/\text{cm}$  at 24.3°C).

### 6.5.3 Min/max values of the optional inputs

MIN/MAX OPT. INP.	
1:	-----
2:	-0.01      5.00 pH
3:	-93.25    -----

#### Activating the display

The instrument is in Measuring mode (normal display)

- \* Briefly press the ▲ or ▼ key (several times if necessary).  
Minimum and maximum values of the optional inputs (1, 2 and 3) are displayed

### 6.5.4 Output level

OUTPUT	
CTRL. 1	0 %
CTRL. 2	100 %

#### Activating the display

The instrument is in Measuring mode (normal display)

- \* Briefly press the ▲ or ▼ key (several times if necessary).  
The current output levels of the controller outputs.

### 6.5.5 Current values of the main entries

08:01:30	
MAIN VAL.	817 $\mu\text{S}/\text{cm}$
TEMP. INP.	24.4 °C

#### Activating the display

The instrument is in Measuring mode (normal display)

- \* Briefly press the or ▼ key (several times if necessary).  
The current values of the main output are displayed.

### 6.5.6 Current values of the optional entries

OPT. IN 1	0
OPT. IN 2	0
OPT. IN 3	0

#### Activating the display

The instrument is in Measuring mode (normal display)

- \* Briefly press the ▲ or ▼ key (several times if necessary).  
The current values of the optional inputs (1, 2 and 3) are displayed

### 6.5.7 Current values of the math channels

MATHS 1	8888
MATHS 2	8888

#### Activating the display

The instrument is in Measuring mode (normal display)

- \* Briefly press the ▲ or ▼ key (several times if necessary).  
The current values of the main output are displayed.

### 6.5.8 States of the binary inputs and outputs

OVERVIEW BIN. SIG.							
E1	0	E2	0				
K1	⊙	K2	0	K3	0	K4	0
K5	0	K6	0	K7	0	K8	0

#### Activating the display

The instrument is in Measuring mode (normal display)

- \* Briefly press the ▲ or ▼ key (several times if necessary).  
The states of binary inputs E1 and E2 and of relays K1 through K8 are displayed. In the example shown here, relay K1 is active.

## 6 Operation

---

### 6.5.9 Manual mode overview

#### Analog outputs (optional boards)

In this example, analog outputs 2 and 3 are working normally.

```
MANUAL OVERVIEW
ANALOG INPUT 1  MAN.
ANALOG INPUT 2  ----
ANALOG INPUT 3  ----
```

#### Switching outputs (PSU board and optional boards)

In this example relay output 2 is in Manual mode.

```
MANUAL OVERVIEW
BINARY OUTPUTS
K1 0 K2 @ K3 0 K4 0
K5 0 K6 0 K7 0 K8 0
```

The instrument is in "normal display" mode

\* Briefly press the ▲ or ▼ key (several times if necessary).



Manual mode can only be displayed if at least one output is in Manual mode. For example Administrator level / Parameter level / Binary outputs / Binary output 1 / Manual mode "Active" or "Simulation".

To return to Measuring mode:  
press the **EXIT** key or wait for a "timeout".

---

### 6.5.10 Hardware info



These displays are required for phone support.

---

The instrument is in Measuring mode (normal display)

\* Press and hold the **PGM** and ▲ keys.

```
MAIN CPU 268.01.01-34
MAIN INPUT 269.01.01-04
```

Alternating display



---

```
OPTION 1      200.01.02
OPTION 2
OPTION 3      193.02.01
BOOTLOADER    297.00.01
```

### 6.5.11 Device info







These displays provide an overview of fitted hardware options and the settings of inputs (helpful for troubleshooting, etc.).

- \* Press the  key for longer than 3 seconds.
- \* Briefly press the  or  key (several times if necessary).
- \* Select Device info

```
ADMINISTR. -LEVEL >
CALIBR. -LEVEL >
CALIBR. -LOGBOOK >
DEVICE INFO >
```

- \* Press the  keys.

```
MAIN INP. CR
OPTION 1: ANALOGOUT
OPTION 2: ANALOG IN
OPTION 3: DATALOG.
```

- \* Briefly press the  or  key (several times if necessary).  
For further information about the inputs, press the  or  keys.

## 6.6 User level

All the parameters that the Administrator (See section 6.7 "Administrator level", page 32) has released can be edited at this level. All the other parameters (marked by a key ) are read only.

- \* Press the  key for longer than 2 seconds.
- \* Select "USER LEVEL".

```
USER LEVEL >
ADMINISTR. -LEVEL >
CALIBR. -LEVEL >
CALIBR. -LOGBOOK >
```

## 6 Operation

---

All possible parameters are accessed below. Depending on the configuration of a specific instrument, some of these parameters may not appear.







### 6.6.1 Parameters of the User level

See section 16.2 "Parameters of the User level", page 106.

## 6.7 Administrator level

- All the parameters can be edited at this level.
- At this level, it is also possible to define which parameters can be edited by a "normal" user (operator) and which calibrations can be performed.

To get to the Administrator level, proceed as follows:

- \* Press the  key for longer than 2 seconds.
- \* Use the  or  keys to select "ADMINISTR.-LEVEL".
- \* Use the  and  keys to enter the password 300 (factory setting).
- \* Confirm the  key.

### 6.7.1 Parameter level

The settings that can be made here are the same as those at the User level, See "User level" page 31. As the operator (user) has administrator rights here, the parameters that are locked in the User level can now also be modified.

### 6.7.2 Release level

All parameters can be released (modification possible) or locked (no modification possible) for editing at the User level.

### 6.7.3 Basic setting

The ACM-1 has a basic setting wizard, to make it easier for the user to configure the extensive setting options of the instrument and to avoid configuration conflicts.

The basic settings are reached via ADMINISTR.-LEVEL / PASSWORD / BASIC SETTING.

All the important settings are systematically polled here. At the end, once a request for conformation has been acknowledged, the instrument is initialized with the new settings. Dependent parameters are checked and adjusted.



## Basic setting wizard

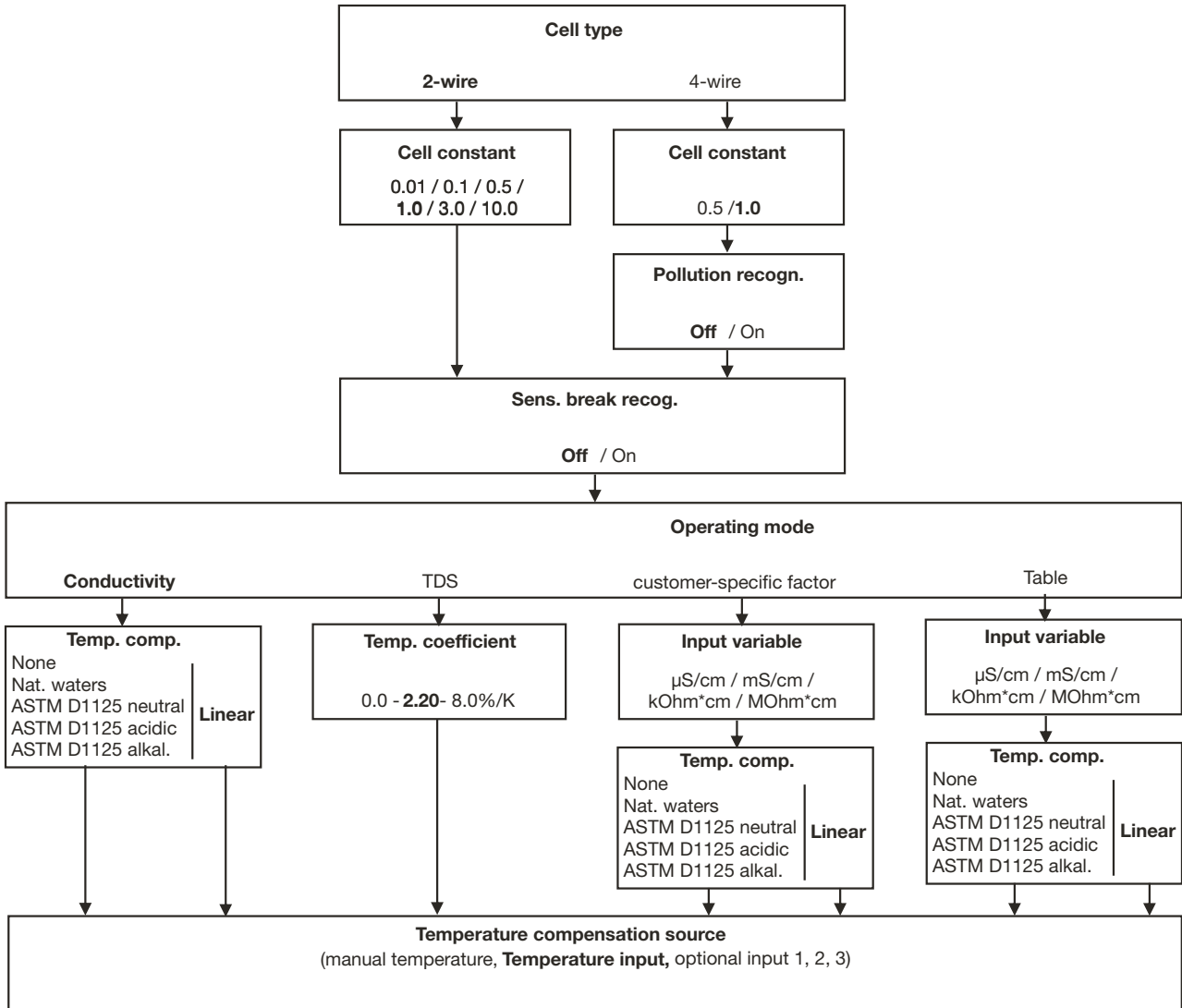

# 6 Operation

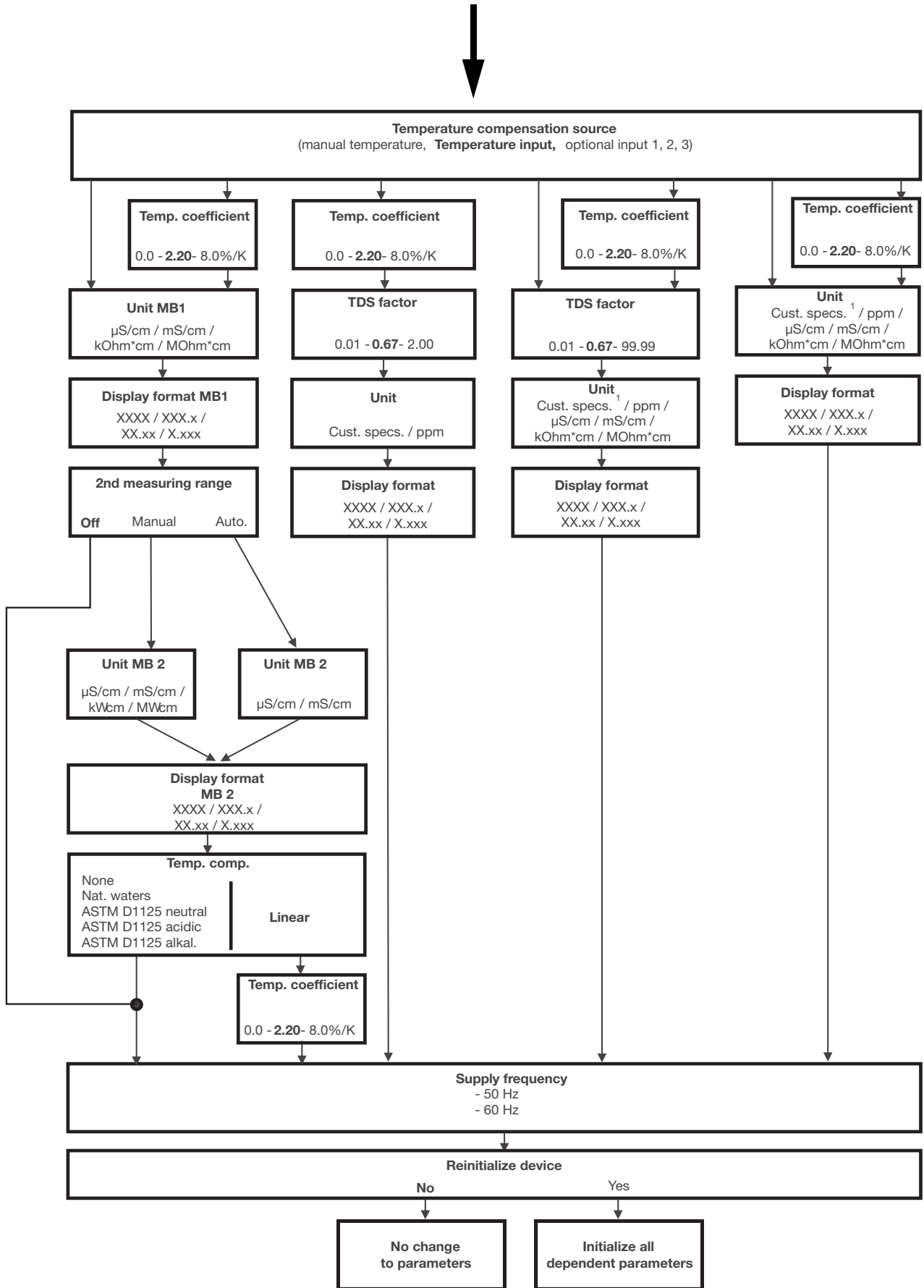

### 6.7.4 Calibration level

Depending on which operating mode has been configured (in the Basic setting menu), one or more of the following calibration options will be available:

- Cell constant
- Temperature coefficient

### 6.7.5 Calibration release

Which calibration procedure may be performed directly and which may not can be configured here, See section 8.2.2 "Ways to start the calibration", page 48.

### 6.7.6 Delete min/max values

If required, the values can be deleted once a request for confirmation has been acknowledged.

See "Min/max values of the main input" page 27 or

See "Min/max values of the optional inputs" page 28.

### 6.7.7 Delete logbook

The last five calibration processes for each input are archived in the calibration logbook. If a "Datalogger" optional board is fitted, the date and time are also archived.

If necessary the logbook can be deleted after a confirmation prompt.

### 6.7.8 Delete daily batch

If required, the counter can be deleted once a request for confirmation has been acknowledged.

### 6.7.9 Delete total batch

If required, the counter can be deleted once a request for confirmation has been acknowledged.

## 6.8 MANUAL mode / Simulation mode

These functions can be used to set the switching outputs and analog outputs of the instrument manually to a defined state. This facilitates dry startup, troubleshooting and customer service, etc. 

Simulation mode accesses the analog outputs and binary outputs **directly**. When simulation mode has been selected, MANUAL mode is **not** possible!

In MANUAL mode the settings for "higher order controllers" are taken into consideration.

# 6 Operation

---

## 6.8.1 MANUAL mode only via "higher order" controller functions

### Select Manual mode



In the factory setting of the instrument the MANUAL mode parameter is locked and can **only be activated by the administrator!**

This parameter must first be released for other users, See "Release level" page 32.

- \* Set ADMINISTR.-LEVEL / PARAMETER LEVEL / CONTROLLER / CTRL.SPEC. FUNCT. / MANUAL MODE "Locked, **Coding** or **Switching**.



Locked = No Manual mode, control is via device.

Coding = The outputs are active as long as the ▼ or ▲ key is pressed.

Switching = the outputs are active if the ▼ or ▲ key is pressed. If the corresponding key is pressed again, the output becomes inactive again.

### Activate Manual mode



The instrument is in Display mode

- \* Press the  and  keys for less than 2 seconds.  
The word MANUAL appears in the status line of the display.





---

If the  keys (alone) are pressed for longer than 3 seconds, the instrument switches to language selection.

If the  and  keys are pressed for longer than 3 seconds, the instrument goes into HOLD mode.

Then the outputs of the instrument respond according to the default settings.

To exit HOLD mode, press the  and  keys for longer than 3 seconds.

---

Control is not longer via the instrument. The output level of the controllers is 0%.

Controller 1 is activated by the  key. In this case the output level of controller 1 is 100%.

Controller 2 is activated by the  key. In this case the output level of controller 2 is 100%.

### Deactivation

- \* Press the  key.

Control is once again through the outputs of the instrument.  
The word MANUAL appears in the status line of the display.

### 6.8.2 Simulation of binary outputs

#### Activate simulation



In the factory setting of the instrument the MANUAL mode parameter is set to "No simulation" and can **only be activated by the administrator!**

This parameter must first be released for other users, See "Release level" page 32.

If a higher order switching function has been assigned to an output, Simulation mode is not possible for that output.

---

\* Set ADMINISTR. LEVEL / PARAMETER LEVEL / BINARY OUTPUTS / BINARY OUTPUT1(...8) "Manual mode no simulation, **Inactive** or **Active**".

No simulation = No Manual mode, control is via device.

Inactive = Relay K1 or K2 is de-energized; the word MANUAL appears in the status line of the display

Active = Relay K1 or K2 is energized; the word MANUAL appears in the status line of the display

#### Deactivate Manual mode

No simulation = No Manual mode, control is via device.

When the instrument is in display mode, the word MANUAL disappears from the status line of the display.

### 6.8.3 Simulation of analog outputs via MANUAL mode

#### Release and activation

\* Select activation of simulation of the actual value output:  
ADMINISTR.-LEVEL / PARAMETER LEVEL / ANALOG OUTPUTS / ANALOG OUTPUT 1 (2, 3) / SIMULATION / ON.

With "On" the output takes on the value of the "Simulation value" parameter.

When the instrument is in display mode, the word MANUAL appears in the status line of the display.

#### Deactivation

\* ADMINISTR.-LEVEL / PARAMETER LEVEL / ANALOG OUTPUTS / ANALOG OUTPUT 1 (2, 3) / SIMULATION / OFF.

The corresponding output of the instrument works again.

When the instrument is in display mode, the word MANUAL disappears from the status line of the display.

---

## 6 Operation

---

### 6.9 HOLD mode

In HOLD status the outputs take on the states programmed in the relevant parameter (controller channel, switching output or analog output).

This function can be used to "freeze" switching outputs and the analog outputs of the instrument. This means the current status of the output will be retained even when the measured value changes. Control is not via the instrument.



---



If MANUAL mode is activated while HOLD mode is activated, MANUAL mode takes precedence and MANUAL then appears in the status line of the display! MANUAL mode can be terminated by pressing the  key.

If HOLD mode is still activated (by the binary input or by keyboard), the instrument then returns to HOLD mode!

---



HOLD mode can be activated by pressing the key or by the binary input.

#### Activation by pressing key

- \* Press and hold the  and  keys longer than 3 seconds. Then the outputs of the instrument respond according to the default settings. The word HOLD appears in the status line of the display.



---

If the  and  keys are pressed for less than 3 seconds, the instrument goes into Manual mode.

Then the outputs of the instrument respond according to the default settings.



---

### Pressing a key to deactivate HOLD mode

\* Press the  and  keys for longer than 3 seconds.



---

If the  and  keys are pressed for less than 3 seconds, the instrument goes into Manual mode.

Then the outputs of the instrument respond according to the default settings.

---

Control is through the outputs of the instrument again. The word MANUAL disappears from the status line of the display.

# 7 Commissioning

---

## 7.1 Getting started

---



Some suggestions follow for configuring the instrument reliably in little time.

---

- \* Mount the instrument, See section 4 "Mounting", page 13.
- \* Install the instrument, See section 5 "Installation", page 14 ff.
- \* Call up Administrator level (ADMINISTR. LEVEL).
- \* Enter password 0300 (factory setting).
- \* Call up PARAMETER LEVEL / DISPLAY / OPERAT. TIMEOUT.
- \* Set OPERAT. TIMEOUT to 0 minutes (no timeout).
- \* Leave the Display level with "EXIT"
- \* Leave the Parameter level with "EXIT"
- \* Select BASIC SETTING and work through all the menu items, See section 6.7.3 "Basic setting", page 32.
- \* Answer "YES" to the "Reinitialize device" query
- \* Configure the required additional parameters.
- \* Calibrate the instrument to the conductivity cell and sample medium, See section 8 "Calibrating a conductivity cell", page 47 or See section 9 "Calibrating a sensor with a standard signal", page 53.



## 7.2 Setting examples

### 7.2.1 Conductivity measurement, temperature compensated



Measurement of drinking water.

#### Layout

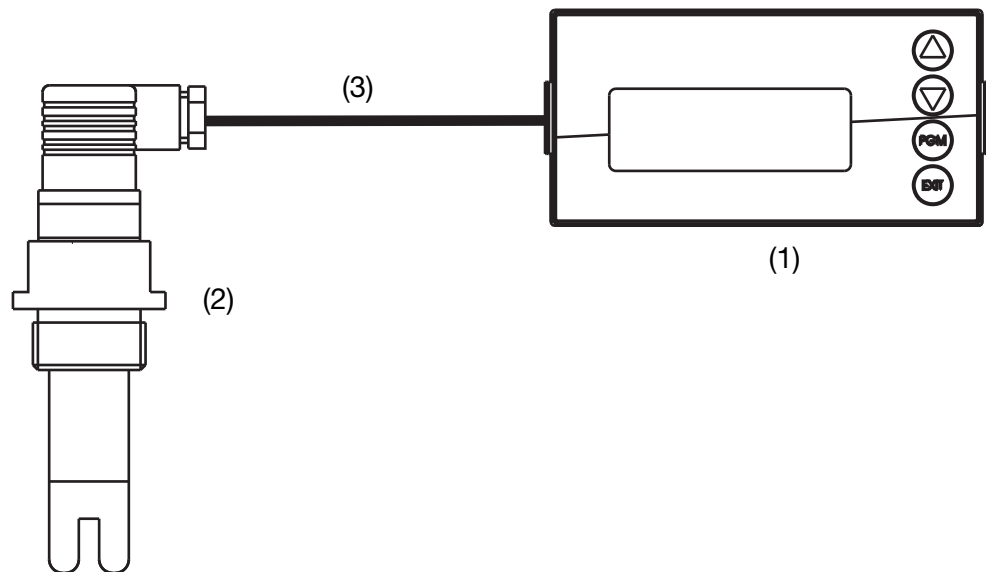

- (1) Transmitter/controller type ACM-1
- (2) Conductivity cell on the main board
- (3) Conductivity cable

#### Electrical connection

See section 5 "Installation", page 14.

#### Task

Measurement range:	0 - 1.00 mS/cm
Cell constant K:	1.0 1/cm
Output signal:	4 - 20 mA
Temperature measurement	Pt100
Limit monitoring:	Limit function
Limit value 1:	0.80 mS/cm

# 7 Commissioning

---

## Basic setting



---

Start the basic settings See section 6.7.3 "Basic setting", page 32  
Diagrammatic overview, See section "Basic setting wizard", page 33.

---

Cell type	2-wire
Cell constant	1.0
Broken sensor detection	Off
Operating mode	Conductivity
Temperature compensation	Linear
Temperature compensation source	Temperature input
Temperature coefficient	2.20 (factory setting)
Unit	mS/cm
Display format	XX.xx
2nd measuring range	Off
Supply frequency	50 Hz
Reinitialize device	Yes

## Temperature input

Administrator level / Password / Parameter level / Temperature input  
Temperature sensor Pt100

## Analog output

Administrator level / Password / Parameter level / Analog outputs / Analog output 1  
Signal source Main variable  
Signal type 4 - 20 mA  
Start of scaling 0.00 mS/cm  
End of scaling 1.00 mS/cm

## Controller settings

See section 11.6.3 "Controller with limit value function", page 79.

## 7 Commissioning

### 7.2.2 Measurement of ultra-pure water with 2-electrode measuring cell



USP limit monitoring.

#### Layout

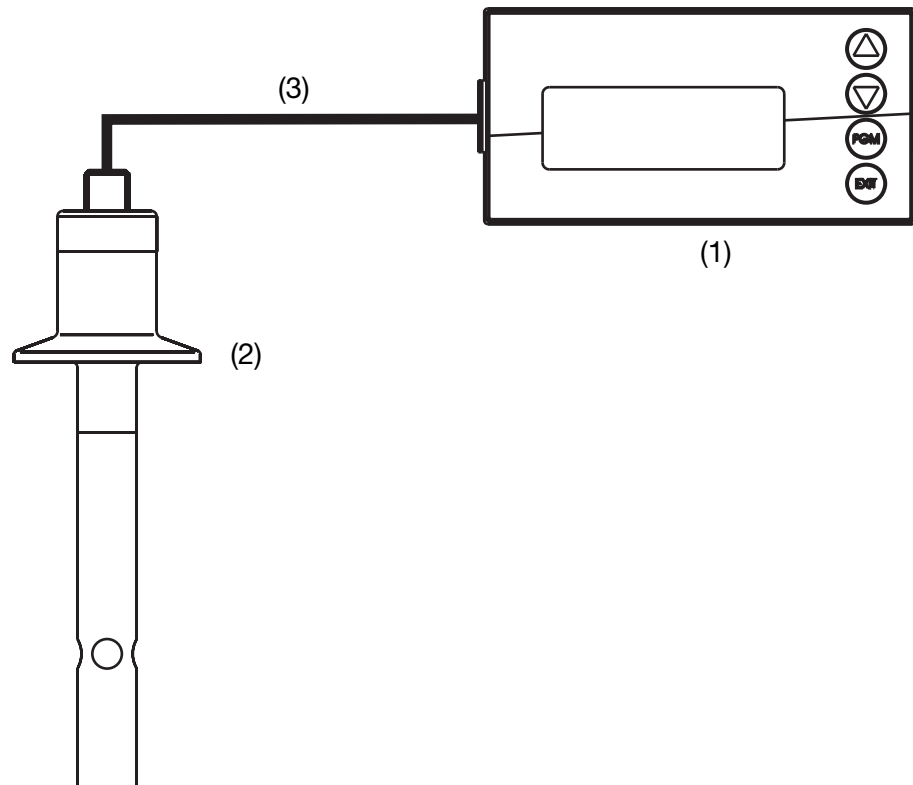

- (1) Transmitter/controller type ACM-1
- (2) Conductivity cell on the main board
- (3) Conductivity cable

#### Electrical connection

See section 5 "Installation", page 14.

#### Task

Measurement range:	0 - 2.00 $\mu\text{S}/\text{cm}$
Cell constant K:	0.01 1/cm
Output signal:	4 - 20 mA
Temperature measurement	Pt100
Limit monitoring:	Limit value function
Limit value 1:	USP

# 7 Commissioning

---

## Basic setting



---

Start the basic settings See section 6.7.3 "Basic setting", page 32  
Diagrammatic overview, See section "Basic setting wizard", page 33.

---

Cell type	2-wire
Cell constant	0.01
Broken sensor detection	Off
Operating mode	Conductivity
Temperature compensation	None
Temperature compensation source	Temperature input
Unit	$\mu\text{S}/\text{cm}$
Display format	X.xxx
2nd measuring range	Off
Supply frequency	50 Hz
Reinitialize device	Yes

## Temperature input

Administrator level / Password / Parameter level / Temperature input  
Temperature sensor Pt100

## Analog output

Administrator level / Password / Parameter level / Analog outputs / Analog output 1

Signal source	Main variable
Signal type	4 - 20 mA
Start of scaling	0.00 $\mu\text{S}/\text{cm}$
End of scaling	2.00 $\mu\text{S}/\text{cm}$

## Controller settings

See section 11.6.2 "Limit monitoring to USP", page 78.

## 7 Commissioning

### 7.2.3 Measurement of ultra-pure water with 2-electrode measuring cell



Display in MOhm x cm.

#### Layout

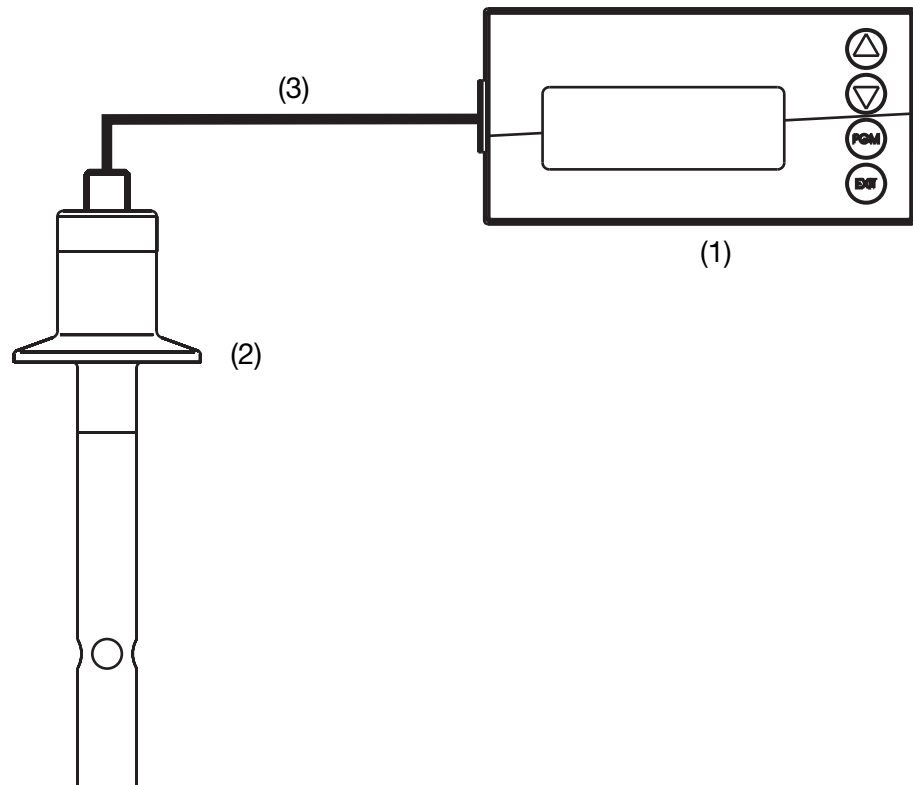

- (1) Transmitter/controller type ACM-1
- (2) Conductivity cell on the main board
- (3) Conductivity cable

#### Electrical connection

See section 5 "Installation", page 14.

#### Task

Measurement range:	0 - 20.00 MOhm x cm
Cell constant K:	0.01 1/cm
Output signal:	4 - 20 mA
Temperature measurement	Pt100
Limit monitoring:	Limit value function
Limit value 1:	10.00 MOhm x cm

# 7 Commissioning

---

## Basic setting



---

Start the basic settings See section 6.7.3 "Basic setting", page 32  
Diagrammatic overview, See section "Basic setting wizard", page 33.

---

Cell type	2-wire
Cell constant	0.01
Broken sensor detection	Off
Operating mode	Conductivity
Temperature compensation	None
Temperature compensation source	Temperature input
Unit	MOhm x cm
Display format	XX.xx
2nd measuring range	Off
Supply frequency	50 Hz
Reinitialize device	Yes

## Temperature input

Administrator level / Password / Parameter level / Temperature input  
Temperature sensor Pt100

## Analog output

Administrator level / Password / Parameter level / Analog outputs / Analog output 1  
Signal source Main variable  
Signal type 4 - 20 mA  
Start of scaling 0.00 MOhm x cm  
End of scaling 20.00 MOhm x cm

## Controller settings

See section 11.6.1 "Simple limit monitoring", page 78.

# 8 Calibrating a conductivity cell

---

## 8.1 Notes



During calibration, relays and analog output signals adopt their configured states!

---



When is calibration required?

- The temperature coefficient of the sample medium must be determined once.
- The cell constant must be calibrated at regular intervals (depending on the sample medium and requirements).

Every successfully completed calibration is documented in the calibration logbook, See section 10 "Calibration logbook", page 73.

---

## 8.2 General information

The electrical properties of all sensors vary slightly from instance to instance and also change during operation (due to deposits or wear, etc.). This changes the output signal of the sensor.

### 8.2.1 Requirements

- The instrument must be supplied with voltage, See section 5 "Installation", page 14 ff.
  - A conductivity cell must be connected to the transmitter.
- 



For a configuration example See section 7.2.1 "Conductivity measurement, temperature compensated", page 41.

A conductivity cell be

- connected directly to the main input or
  - connected to the "Analog input (universal)" optional board via a transmitter.
- 

- "Conductivity" must be configured as operating mode in the basic setting.
  - The instrument is in Measuring mode.
-

## 8 Calibrating a conductivity cell

---

### 8.2.2 Ways to start the calibration

Select the input to which the conductivity cell is connected.

```
MAIN INPUT  >
OPT. INPUT 2  >
```

#### If Calibration level is not released

- Press the **PGM** key for longer than 3 seconds / ADMINISTR.-LEVEL / PASSWORD / CALIBR.-LEVEL / MAIN INPUT or ANALOG INPUT.

#### If Calibration level is released

- Press the **PGM** and **▼** keys simultaneously / MAIN INPUT or ANALOG INPUT.

#### If Calibration level is released

- Press the **PGM** key for longer than 3 seconds / CALIBR.-LEVEL / MAIN INPUT or ANALOG INPUT.

### 8.2.3 Calibration options

The instrument provides two calibration options for adjusting the ACM-1 to the measuring point:

#### Calibration of the temperature coefficient

See section 8.4 "Calibrating the relative cell constant", page 51.

#### Calibration of the cell constant

See "Calibrating the relative cell constant" page 51.

## 8.3 Calibration of the temperature coefficient of the sample medium

- \* Make preparations, See section 8.2 "General information", page 47.
- \* Start calibration, See section 8.2.2 "Ways to start the calibration", page 48.
- \* Select "TEMP.COEFF. LIN."

```
TEMP.COEFF. LIN. >
REL. CELL CONST. >
```



## 8 Calibrating a conductivity cell



Now the source of temperature acquisition can be selected (manually, or using the temperature input of the PSU board, or the temperature input via the optional board). This source will be active for the duration of the calibration.

An example follows: automatic temperature acquisition using the temperature sensor integrated into the conductivity cell.

10:15:31	CALIB
TEMP.-COMP. SOURCE	
TEMPERATURE INPUT	

The current sensor temperature appears in the display (+ flashing) (1).

CALIB	
ENTRY	24.3 °C
WORK. TEMP	
< 20.0 °C	> 30.0 °C

 (1)

\* Enter the required working temperature and confirm your entry with the  key.



The working temperature must be at least 5°C above or below the reference temperature (25.0°C).

CALIB		
T1	25.0 °C	399
T2	70.0 °C	µS/cm
		24.3 °C

The conductivity (399 µS/cm) at the current temperature (24.3°C) now appears on the right of the LC display.

The temperatures T1 (25°C) and T2 (70.0°C) that have yet to be triggered are shown on the left.

\* Heat the sample medium until the working temperature is reached.



During calibration, the rate of temperature change in the measurement solution must not exceed 10°C/min.

## 8 Calibrating a conductivity cell

---



Calibration is also possible in the cooling process (with a falling temperature). It starts above the working temperature and ends below the working temperature.

---

As soon as the temperature of the sample medium exceeds T1 (25°C), this is hidden on the display. The uncompensated conductivity at the current temperature is displayed on the right.

CALIB		
T2	73.0 °C	800 µS/cm 74.3 °C

If the temperature of the medium exceeded T2 (73.0°C), the instrument determines the temperature coefficient.

The LC display now shows the determined temperature coefficient as %/K.

CALIB	
TEMPCO.	1.99 %

\* Use the **PGM** key to accept the temperature coefficient or the **EXIT** key to reject it.

The transmitter is in "measuring mode" and displays the compensated conductivity of the solution.

MEASURING	405
74.2°C	µS/cm



The currently measured conductivity can be coerced manually by pressing the **PGM** key. This may be useful if the reference or working temperature cannot be reached precisely.

However, the calibration result incorporates a certain amount of inaccuracy!

---

## 8 Calibrating a conductivity cell

### 8.4 Calibrating the relative cell constant

- \* Make preparations, See section 8.2 "General information", page 47.
- \* Start calibration, See section 8.2.2 "Ways to start the calibration", page 48.
- \* Select the relative cell constant.

```
TEMP. COEFF. LIN. >
REL. CELL CONST. *
```

- \* Immerse the conductivity cell in a reference solution with a known conductivity.



The measurement solution must maintain a constant temperature during calibration! The conductivity cell must be kept at a distance of at least 20 mm from the container wall during the calibration and must not be moved!

The current measurement value and the temperature are displayed.

```
CALIB MAN.
MEAS. 402
REFERENCE  µS/cm
          25.1 °C
```

- \* When the measurement value is steady, press the **PGM** key; the conductivity measurement flashes in the display.
- \* Set the value to the actual conductivity.
- \* Press the **PGM** key. The relative cell constant determined by the instrument is displayed (as a %).

```
CALIB MAN.
CELL CONST 100.9 %
```

- \* Use the **PGM** key to accept the value or the **EXIT** key to reject it.
- \* The current measurement value and the temperature are displayed.

## 8 Calibrating a conductivity cell

---

### 8.4.1 Entering the cell constant manually



If the exact cell constant is known (for example a measuring cell with the ASTM test report), the value can be entered directly.

---

ADMINISTR.-LEVEL / PARAMETER LEVEL / INPUT CONDUCT. /REL. CELL CONST.

### 8.4.2 Cell constants

#### Two-electrode systems

Cell constant [1/cm]	Setting range of the relative cell constant	Resulting usable range [1/cm]
0.01	20 - 500%	0.002 - 0.05
0.1		0.02 - 0.5
1.0		0.2 - 5
3.0		0.6 - 15
10.0		2.0 - 50

#### Four-electrode systems

Cell constant [1/cm]	Setting range of the relative cell constant	Resulting usable range [1/cm]
0.5	20 - 150%	0.1 - 0.75
1.0		0.2 - 1.5

# 9 Calibrating a sensor with a standard signal

---

## 9.1 General information



---

During calibration, relays and analog output signals adopt their configured states!

---



---

Sensors with a standard signal output can only be connected to an "Analog input (universal)" optional board!

The sensors connected to the instrument should be cleaned and the instrument itself calibrated, at regular intervals (subject to the sample medium).

Every successfully completed calibration is documented in the calibration logbook, See section 10 "Calibration logbook", page 73.

---

### 9.1.1 Operating modes

The operating mode selection depends on which sensor (transmitter) is connected.

#### Linear operating mode

For example sensor for free chlorine, redox, pressure, liquid level or humidity

#### pH operating mode

For example pH sensor

#### Conductivity operating mode

For example sensor for conductivity, concentration

#### Customer specs.

For sensors with non-linear characteristics.

Up to xx interpolation points can be defined in an instrument table.

This allows for an excellent approximation of a non-linear characteristic.

#### Chlorine, pH and temperature-compensated

Combination of chlorine sensor and pH sensor and temperature sensor.

The measured value for chlorine often depends to a great extent on the pH value of the solution.

The chlorine measurement is compensated depending on the pH value in this operating mode. The pH measurement is temperature-compensated

## 9 Calibrating a sensor with a standard signal

### 9.1.2 Calibration options

Different calibration options are available depending on the operating mode.

Operating mode	Calibration options					Page
	1-point	2-point	Limit point	Rel. cell const.	Temp. coefficient	
Linear	X	X	X	-	-	55
pH	X	X	-	-	-	59
Conductivity	-	-	-	X	X	63
Concentration	-	-	-	X		69
Customer specs.	Due to the table with interpolation points, no calibration is required					
Chlorine, pH-compensated	-	-	X	-	-	71

- With **one-point (offset) calibration**, the zero point of the sensor is calibrated.
- With **two-point calibration**, the zero point and slope of the sensor are calibrated. This is the recommended calibration for most sensors.
- With **one-point final value calibration**, the slope of the sensor is calibrated. This is the recommended calibration for chlorine sensors, for example.
- **Calibration of relative cell constant**  
With conductivity measuring cells only.
- **Calibration of the temperature coefficient**  
With conductivity measuring cells only.

### 9.1.3 Ways to start the calibration

Select the input to which the sensor is connected.



#### If Calibration level is not released

- Press the  key for longer than 3 seconds / ADMINISTR.-LEVEL / PASSWORD / CALIBR.-LEVEL / OPTION INPUT.

#### If Calibration level is released

- Press the  and  keys simultaneously / OPTION INPUT.

#### If Calibration level is released

- Press the  key for longer than 3 seconds / CALIBR.-LEVEL / OPTION INPUT.

# 9 Calibrating a sensor with a standard signal

## 9.2 Linear operating mode

### 9.2.1 1-point calibration



This example is based on a liquid level measurement (as a %).  
The input signal is provided by a pressure transmitter.

- The transmitter is in "Measuring mode".

```
MAIN VAL.    6.89 µS/cm
TEMP. INP.   25.0 °C
OPT. IN 3    2.5 %
```

- \* Now bring the system to a defined state (e.g. when measuring liquid level, empty the container).
- \* Start the calibration, See "Ways to start the calibration" page 54.
- \* Select the zero point calibration with the **PGM** key.

```
ZERO POINT  >
LIMIT POINT >
2-POINT     >
```

- \* Wait until the display value has stabilized; then press **PGM** to continue.

```
          CALIB
MEASUREM.          2.5
REFERENCE          %
```

Set the displayed value to the required value (usually 0%) with the **▼** and **▲** keys; then press **PGM** to continue.

```
          CALIB
INPUT           +000.0
REFERENCE          %
```

The zero point determined by the instrument is displayed.

Use the **PGM** key to accept the value or  
the **EXIT** key to reject it.

## 9 Calibrating a sensor with a standard signal

---

The instrument returns to Measuring mode.

MAIN VAL.	6.89 $\mu\text{S/cm}$
TEMP. INP.	25.0 $^{\circ}\text{C}$
OPT. IN 3	0.0 %

### Calibration is complete

After rinsing, the sensor can again be used to take measurements.

### 9.2.2 Two-point calibration



---

The values determined during calibration (zero point and slope) work out as follows:

$$\text{Display} = \frac{\text{Input value}}{\text{Slope}} + \text{Zero point}$$

This example is based on a liquid level measurement. The input signal is provided by a pressure transmitter.

---

- The transmitter is in "Measuring mode".

MAIN VAL.	6.89 $\mu\text{S/cm}$
TEMP. INP.	25.0 $^{\circ}\text{C}$
OPT. IN 3	2.5 %

- \* Now bring the system to a defined state (e.g. when measuring liquid level, empty the container).
- \* Start the calibration, See "Ways to start the calibration" page 54.
- \* Select the 2-point calibration with the  key.

ZERO POINT	>
LIMIT POINT	>
2-POINT	>

- \* Wait until the display value has stabilized; then press  to continue.



## 9 Calibrating a sensor with a standard signal

CALIB	
MEASUREM.	2.5
REF. 1	%

- \* Set the displayed value to the required value (usually 0) with the  $\blacktriangledown$  and  $\blacktriangle$  keys; then press  $\text{PGM}$  to continue.

CALIB	
INPUT	0.0
REF. 1	%

- \* Now bring the system to a second defined state (e.g. when measuring liquid level, container full).  
Wait until the display value has stabilized; then press  $\text{PGM}$  to continue

CALIB	
MEASUREM.	94.9
REF. 2	%

- \* Set the displayed value to "Maximum" (usually 100%) with the  $\blacktriangledown$  and  $\blacktriangle$  keys; then press  $\text{PGM}$  to continue.

CALIB	
INPUT	100.0
REF. 2	%

The zero point and slope determined by the instrument are displayed.

- \* Use the  $\text{PGM}$  key to accept the calibrated values or reject them with the  $\text{EXIT}$  key.

CALIB	
ZERO POINT	-2.7%
SLOPE	108.2%

- \* The instrument returns to Measuring mode.

MAIN VAL.	6.89 $\mu\text{S/cm}$
TEMP. INP.	25.0 $^{\circ}\text{C}$
OPT. IN 3	100.0 %

## 9 Calibrating a sensor with a standard signal

---

### Calibration is complete

After rinsing, the sensor can again be used to take measurements.

### 9.2.3 Calibration limit point



---

This example is based on a measurement of free chlorine. The input signal is provided by a corresponding transmitter.

---

- The transmitter is in "Measuring mode".



MAIN VAL.	6.89 $\mu\text{S}/\text{cm}$
TEMP. INP.	25.0 °C
OPT. IN 3	1.61 PPM

- \* The process must now be brought to the state that is as relevant as possible to the final value (e.g. when measuring chlorine, the required concentration).
- \* Start the calibration, See "Ways to start the calibration" page 54.
- \* Select the limit point calibration with the  key.

ZERO POINT	>
LIMIT POINT	>
2-POINT	>



- \* Wait until the display value has stabilized; then press  to continue.

CALIB	
MEASUREMENT	1.94
REFERENCE	PPM

Set the displayed value to the measured reference value with the  or  keys; then press  to continue.

CALIB	
INPUT	+02.00
REFERENCE	PPM

The slope determined by the instrument is displayed.

- \* Use the  key to accept the value or the  key to reject it.

## 9 Calibrating a sensor with a standard signal

---

CALIB	
SLOPE	97.5%

\* The instrument returns to Measuring mode.

MAIN VAL.	6.89 $\mu\text{S}/\text{cm}$
TEMP. INP.	25.0 °C
OPT. IN 3	1.61 PPM

### Calibration is complete

After rinsing, the sensor can again be used to take measurements.

## 9.3 pH operating mode

### 9.3.1 Zero point (1-point) calibration



This example is based on a glass combination electrode with a connected two-wire transmitter.

- The transmitter is in "Measuring mode".

10:42:08	
MAIN VAL.	6.89 $\mu\text{S}/\text{cm}$
TEMP. INP.	5.00 pH
OPT. IN 3	24.4 °C

\* Perform calibration as follows.

#### Zero point (1-point) calibration

\* Make preparations, See section 8.2 "General information", page 47 .

\* Start calibration, See section 8.2.2 "Ways to start the calibration", page 48.

\* Select zero point calibration.

ZERO POINT	>
2-POINT	>
3-POINT	>

\* Immerse the combination electrode in a buffer solution with a known pH

## 9 Calibrating a sensor with a standard signal

---

value.

- \* Start the zero point calibration with the  key.





Now the source of temperature acquisition can be selected (manually, or using the temperature input of the PSU board, or the temperature input via the optional board). This source will be active for the duration of the calibration.

An example follows: manual temperature entry.

---



CALIB	
TEMP. -COMP. SOURCE	
MAN. TEMPERATURE	

- \* To enter the temperature manually, use the  and  keys to set the calibration solution temperature and confirm your entry with the  key.



E1	CALIB
INPUT	+025.0 °C
TEMP.	

- \* Wait until the display value has stabilized; then press  to continue.

CALIB	
MEASUREMENT	6.02
REFERENCE	pH
	25.0 °C

- \* Set the displayed value to the buffer solution value with the  or  keys; then press  to continue.

E1	CALIB
INPUT	+06.10
REFERENCE	pH

- \* Use the  key to accept the zero point or the  key to reject it.

CALIB	
ZERO POINT	7.10pH

## 9 Calibrating a sensor with a standard signal

---

The instrument returns to Measuring mode.

```
10:42:08
MAIN VAL. 6.89 µS/cm
TEMP. INP. 5.00 pH
OPT. IN 3 24.4 °C
```

### 9.3.2 2-point calibration



This example is based on a glass combination electrode with a connected two-wire transmitter.

- The transmitter is in "Measuring mode".

```
10:42:08
MAIN VAL. 6.89 µS/cm
TEMP. INP. 5.00 pH
OPT. IN 3 24.4 °C
```

\* Perform calibration as follows:

#### 2-point calibration



The buffer solutions (reference solutions) used for calibration must differ by at least 2 pH!

During the calibration, the temperature of the two buffer solutions must be identical and remain constant!

- \* Make preparations, See section 8.2 "General information", page 47 .
- \* Start calibration, See section 8.2.2 "Ways to start the calibration", page 48.
- \* Select 2-point calibration.

```
ZERO POINT >
2-POINT >
3-POINT >
```

- \* Immerse the combination electrode in the first buffer solution with the known pH value.
- \* Start the two-point calibration with the  key.

## 9 Calibrating a sensor with a standard signal



Now the source of temperature acquisition can be selected (manually, or using the temperature input of the PSU board, or the temperature input via the optional board). This source will be active for the duration of the calibration.

An example follows: manual temperature entry.

CALIB	
TEMP. -COMP. SOURCE	
MAN. TEMPERATURE	

- \* To enter the temperature manually, use the and keys to set the calibration solution temperature and confirm your entry with the key.

E1	CALIB
INPUT	+025.0 °C
TEMP.	

- \* Wait until the display value has stabilized; then press to continue.

CALIB	
MEASUREMENT.	7.06
REF. 1	pH
	25.0 °C

- \* Set the displayed value to the value of the first buffer solution with the and keys; then press to continue.

CALIB	
INPUT	+07.03
REF. 1	pH

- \* Rinse and dry the pH combination electrode.
- \* Immerse the pH combination electrode in the second buffer solution.
- \* Wait until the display value has stabilized; then press to continue.

CALIB	
MEASUREMENT.	4.03
REF. 2	pH
	25.0 °C

- \* Set the displayed value to the second buffer solution value with the or

## 9 Calibrating a sensor with a standard signal

 keys; then press  to continue.

CALIB	
INPUT	+04.01
REF. 2	pH

The zero point and slope determined by the instrument are displayed.

- \* Use the  key to accept the calibrated values or reject them with the  key.

CALIB	
ZERO POINT	7.03pH
SLOPE	99.4%

The instrument returns to Measuring mode.

10:42:08	
MAIN VAL.	6.89 $\mu\text{S}/\text{cm}$
TEMP. INP.	5.00 pH
OPT. IN 3	24.4 °C

### 9.4 Conductivity operating mode

#### 9.4.1 Calibration of the relative cell constant



This example is based on a conductivity cell with a connected two-wire transmitter.

- The transmitter is in "Measuring mode".

MAIN VAL.	6.89 $\mu\text{S}/\text{cm}$
TEMP. INP.	25.0 °C
OPT. IN 3	109 $\mu\text{S}/\text{cm}$

- \* Immerse the conductivity cell in a reference solution with a known conductivity.
- \* Start the calibration, See "Ways to start the calibration" page 54.
- \* Select REL. CELL CONST.
- \* Press the  key.

## 9 Calibrating a sensor with a standard signal

---

```
TEMP. COEFF. LIN. >
REL. CELL CONST. >
```

- \* When the measured value is stable, press the **PGM** key

```
          CALIB
MEASUREM.    1950
REFERENCE    µS/cm
```

- \* The measured conductivity value flashes on the display.

```
          CALIB
INPUT        +02000
REFERENCE    µS/cm
```

- \* Use the **▼** or **▲** keys to set the value to the actual conductivity.
- \* Press the **PGM** key;  
the relative cell constant determined by the instrument is displayed (as a %).

```
          CALIB
CELL CONST   102.6 %
```

- \* Use the **PGM** key to accept the temperature coefficient or  
the **EXIT** key to reject it.

```
MAIN VAL.    6.89 µS/cm
TEMP. INP.   25.0 °C
OPT. IN 3    2001 µS/cm
```

The current measurement value and the temperature are displayed.

### Calibration is complete

After rinsing, the sensor can again be used to take measurements.



## 9 Calibrating a sensor with a standard signal

### 9.4.2 Calibration of the temperature coefficient

#### Linear temperature coefficient



This example is based on a conductivity cell with a connected two-wire transmitter.

- The transmitter is in "Measuring mode".

MAIN VAL.	6.89 $\mu\text{S}/\text{cm}$
TEMP. INP.	25.0 $^{\circ}\text{C}$
OPT. IN 3	109 $\mu\text{S}/\text{cm}$

\* Immerse the conductivity cell in the sample medium.

Start the calibration, See "Ways to start the calibration" page 54.

\* Select "LINEAR TEMP. COEF".

TEMP. COEFF. LIN.	>
REL. CELL CONST.	>

The current sensor temperature flashes in the display (1).

CALIB	
INPUT	024.4 $^{\circ}\text{C}$ (1)
WORK-TEMP.	
< 20.0 $^{\circ}\text{C}$	> 30.0 $^{\circ}\text{C}$



The working temperature must be at least 5 $^{\circ}\text{C}$  above or below the reference temperature (25.0 $^{\circ}\text{C}$ ).

\* Enter the required working temperature and confirm your entry.

The LC display now shows the selected working temperature (flashing) (2).

CALIB	
INPUT	+075.0 $^{\circ}\text{C}$ (2)
WORK-TEMP.	
< 20.0 $^{\circ}\text{C}$	> 30.0 $^{\circ}\text{C}$

## 9 Calibrating a sensor with a standard signal

---

- \* Press the **PGM** key.

CALIB		
T1	25.0 °C	416
T2	74.4 °C	μS/cm
		24.5 °C

The conductivity (399 μS/cm) at the current temperature (24.3°C) now appears on the right of the LC display.

The temperatures T1 (25°C) and T2 (70.0°C) that have yet to be triggered are shown on the left.

- \* Press the **PGM** key.

- \* Heat the sample medium until the working temperature is reached.



During calibration, the rate of temperature change in the measurement solution must not exceed 10°C/min.

Calibration is also possible in the cooling process (with a falling temperature). It starts above the working temperature and ends below the working temperature.

As soon as the temperature of the sample medium exceeds T1 (25°C), this is hidden on the display. The uncompensated conductivity at the current temperature is displayed on the right.

CALIB		
T2	75.0 °C	833
		μS/cm
		74.6 °C

If the temperature of the medium exceeded T2 (73.0°C), the instrument determines the temperature coefficient.

The LC display now shows the determined temperature coefficient as %/K.

CALIB	
TEMP. COEFF	1.99 %/K

- \* Use the **PGM** key to accept the temperature coefficient or the **EXIT** key to reject it.

MAIN VAL.	6.89 μS/cm
TEMP. INP.	25.0 °C
OPT. IN 3	423 μS/cm

## 9 Calibrating a sensor with a standard signal

The transmitter is in "Measuring mode" and displays the compensated conductivity of the solution.

### Calibration is complete

After rinsing, the sensor can again be used to take measurements.

### With non-linear temperature coefficient (TEMP. COEFF. CURVE)



This example is based on a conductivity cell with a connected two-wire transmitter.

The non-linear temperature coefficient can **only** be calibrated with a rising temperature!

The start temperature **must be below** the configured reference temperature (usually 25°C)!

The "TEMP.COEFF. CURVE" menu item is only displayed if a temperature sensor is connected and "TEMP.COEFF. CURVE" is configured as the type of temperature compensation.

- The transmitter is in "Measuring mode".

```
MAIN VAL. 6.89 µS/cm
TEMP. INP. 25.0 °C
OPT. IN 3 109 µS/cm
```

\* Immerse the conductivity cell in the sample medium.

Start the calibration, See "Ways to start the calibration" page 54.

\* Select "TEMP. COEFF. CURVE" and press the  key.

```
TEMP. COEFF. CURVE >
REL. CELL CONST. >
```

\* Enter the required start temperature (1) for the temp. coef. curve.

```
CALIB
INPUT +024.0 °C (1)
START TEMP
```

\* Enter the required end temperature (2) for the temp. coef. curve.

```
CALIB
INPUT +075.0 °C (2)
END TEMP
```

## 9 Calibrating a sensor with a standard signal

- \* Heat the sample medium continuously
  - (3) the current uncompensated conductivity
  - (4) the current temperature of the sample medium
  - (5) the first target temperature

CALIB	
NEXT	416
TEMP.	$\mu\text{S}/\text{cm}$
24.0°C	22.3 °C

(5)

(3)

(4)



During calibration, the rate of temperature change in the measurement solution must not exceed 10°C/min.

During the calibration process, the instrument displays values for the following five temperature interpolation points.

CALIB	
NEXT	416
TEMP.	$\mu\text{S}/\text{cm}$
24.0°C	22.3 °C

### The end temperature has been reached

Use the  key to accept the temperature coefficients or the  key to reject the calibration result.

CALIB	
1: 3.91 %/K	2: 3.67 %/K
3: 3.35 %/K	4: 3.12 %/K
5: 2.87 %/K	6: 2.51 %/K

The LC display now shows the determined temperature coefficients as %/K.

- \* Use the  key to accept the temperature coefficients or the  key to reject the values.

MAIN VAL.	6.89 $\mu\text{S}/\text{cm}$
TEMP. INP.	25.0 °C
OPT. IN 3	423 $\mu\text{S}/\text{cm}$

The transmitter is in "Measuring mode" and displays the compensated conductivity of the solution.

### Calibration is complete

After rinsing, the sensor can again be used to take measurements.

## 9 Calibrating a sensor with a standard signal

### 9.5 Concentration operating mode

#### 9.5.1 Calibration of the relative cell constant



This example is based on a conductivity cell with a connected two-wire transmitter.

The conductivity of a caustic solution is converted into a concentration value [%] by the instrument.

- The transmitter is in "Measuring mode".

MAIN VAL.	6.89 $\mu$ S/cm
TEMP. INP.	25.0 °C
OPT. IN 3	1.4 %



- \* Immerse the conductivity cell in a sample medium with a known conductivity.
- \* Start the calibration, See "Ways to start the calibration" page 54.
- \* Press the  key.

REL. CELL CONST.	>
------------------	---

The measured conductivity value is displayed.

- \* Wait until the measurement value has stabilized.
- \* Press the  key.

CALIB	
MEASUREMENT	104
REFERENCE	mS/cm

- \* Use the  and  keys to set the value to the actual conductivity.

CALIB	
INPUT	+00107
REFERENCE	mS/cm

- \* Press the  key; the relative cell constant determined by the instrument is

## 9 Calibrating a sensor with a standard signal

---

displayed (as a %).

CALIB	
CELL CONST	103.3 %

- \* Use the  key to accept the relative cell constant or the  key to reject the values.

MAIN VAL.	6.89 $\mu\text{S}/\text{cm}$
TEMP. INP.	25.0 $^{\circ}\text{C}$
OPT. IN 3	1.4 %

The transmitter is in "Measuring mode" and displays the compensated conductivity of the solution.

### Calibration is complete

After rinsing, the sensor can again be used to take measurements.

## 9 Calibrating a sensor with a standard signal

### 9.6 Chlorine measurement operating mode, pH-compensated

#### 9.6.1 Final value calibration



The pH signal and temperature signal are supplied via the main input, the chlorine signal (standard signal) via the optional input.

- The transmitter is in "Measuring mode".

MAIN VAL.	7.00 pH
TEMP. INP.	24.2 °C
OPT. IN 3	1.04 PPM

#### Calibrate pH sensor

- \* Perform calibration, See "pH operating mode" page 59.



#### Calibrate chlorine sensor

- \* The process must now be brought to the state that is as relevant as possible to the final value (e.g. when measuring chlorine, the required concentration).
- \* Start the calibration, See "Ways to start the calibration" page 54.
- \* Select the limit point calibration with the  key.

LIMIT POINT	➤
-------------	---

- \* Wait until the display value has stabilized; then press  to continue.

CALIB	
MEASUREMENT	1.94
REFERENCE	PPM

- Set the displayed value to the measured reference value with the  or  keys; then press  to continue.

## 9 Calibrating a sensor with a standard signal

---

CALIB	
INPUT	+02.00
REFERENCE	PPM

The slope determined by the instrument is displayed.

\* Use the  key to accept the value or the  key to reject it.

CALIB	
SLOPE	97.5%

The instrument returns to Measuring mode.

MAIN VAL.	6.89 $\mu\text{S}/\text{cm}$
TEMP. INP.	25.0 $^{\circ}\text{C}$
OPT. IN 3	1.61 PPM

### Calibration is complete

After rinsing, the sensor can again be used to take measurements.



## 10.1 General information

The characteristic data for the last 5 successful calibration processed are documented in the calibration logbook.

### Calling up

The instrument is in Measuring mode.

\* Press the  key for longer than 3 seconds.

```
USER LEVEL >
ADMINISTR.-LEVEL >
CALIBR.-LEVEL >
CALIBR.-LOGBOOK >
```

### Select input

Briefly press the  key.

```
MAIN INPUT >
OPT. INPUT 1 >
OPT. INPUT 2 >
OPT. INPUT 3 >
```

### Most recent successful calibration



The "time stamp" in the following screen printouts (top left, for example 11-06-06 12:02) only appears if optional slot 3 is fitted with the "Datalogger with interface RS485"!

\* Briefly press the  key.

```
11-06-15 08:46
ZELLENK. 100.1 %
MESSBER. 1
```

### Next most recent successful calibration

\* Briefly press the  key.

```
11-06-14 14:57
TK 2.96 %/K
TEMP. 1 24.4 °C
TEMP. 2 73.9 °C
```

# 11 Controller

---

## 11.1 General information



Apart from faulty installation, incorrect settings on the instrument may also affect the proper functioning of the subsequent process or lead to damage. You should therefore always provide safety equipment that is independent of the instrument and it should only be possible for qualified personnel to make settings.

---

## 11.2 Controller functions



"Software" control functions are assigned to "Hardware" outputs for this instrument.

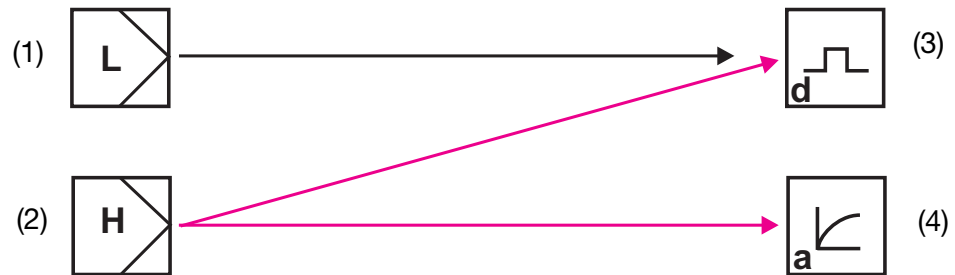

- 1 Software controller for "simple" switching functions (e.g. alarm control)
  - 2 Software controller for "higher order" switching functions (e.g. PID controller)
  - 3 "Switching" hardware output (e.g. relay)
  - 3 "Continuous" hardware output (analog output)
- 

### 11.2.1 Simple switching functions





Up to four switching functions can be set (limit value 1, 2, 3, 4)  
ADMINISTR.-LEVEL / PARAMETER LEVEL / LIMIT VALUE CONTR. / LIMIT VALUE x.

### 11.2.2 Higher order switching functions (PID)

Higher order switching functions are configured at the parameter level via the parameters of "Controller 1 or 2".

ADMINISTR.-LEVEL / PARAMETER LEVEL / CONTROLLER / CONTROLLER 1(2) / CONFIGURATION / CONTROLLER TYPE / e.g. PULSE LENGTHS

## 11.2.3 Typical operator level parameters

Binary outputs	Explanation
Signal source	
No signal	No switching function desired
Limit control 1 to 4	"Simple" switching functions
Alarm function (AF1)	
Alarm function (AF2)	
Alarm function (AF7)	
Alarm function (AF8)	
Controller 1(2)	"Higher order" switching functions
Limit value Pulse width Pulse frequency Steady Modulating	

## 11.3 Software controllers and outputs

### Simple controller functions

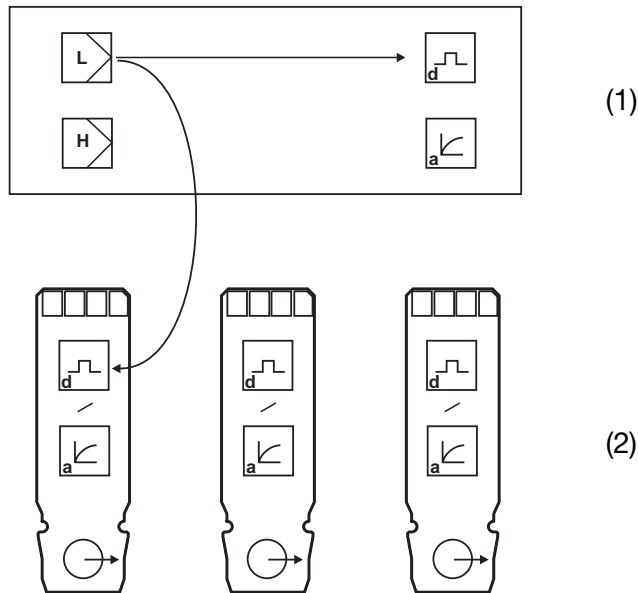

- 1 Main board
- 2 Optional board
- L Simple controller
- H Higher order controller
- d Digital output
- a Analog output

# 11 Controller

---



If "Simple controller functions" have been configured, only the digital outputs can be controlled!

The operator must configure which of the digital outputs will be controlled - the main board or optional board 1, 2 or 3

---

## Higher order controller functions

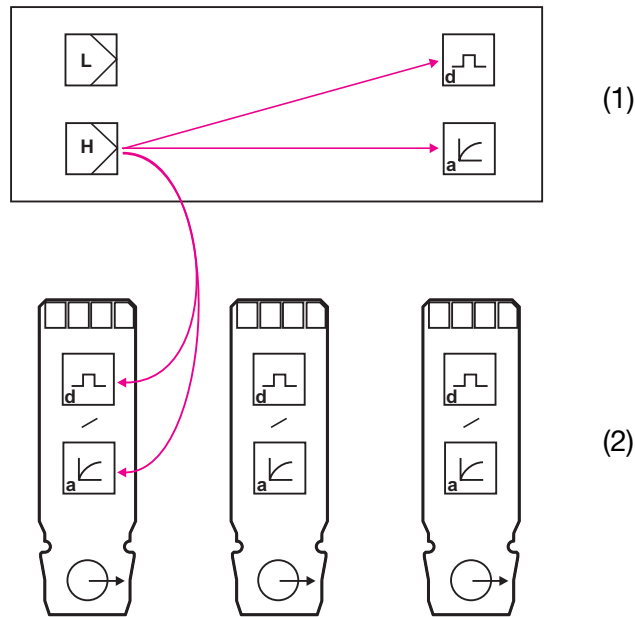

- 1 Main board
- 2 Optional board
- L Simple controller
- H Higher order controller
- d Digital output
- a Analog output



If "higher order controller functions" have been configured, both the digital outputs and the analog outputs can be controlled.

The operator must configure which of the outputs will be controlled - the main board or optional board 1, 2 or 3

---



Additional explanations, See section 16.1 "Glossary", page 94.

---

## 11.4 Configuration of higher order controllers

### 11.4.1 Structure

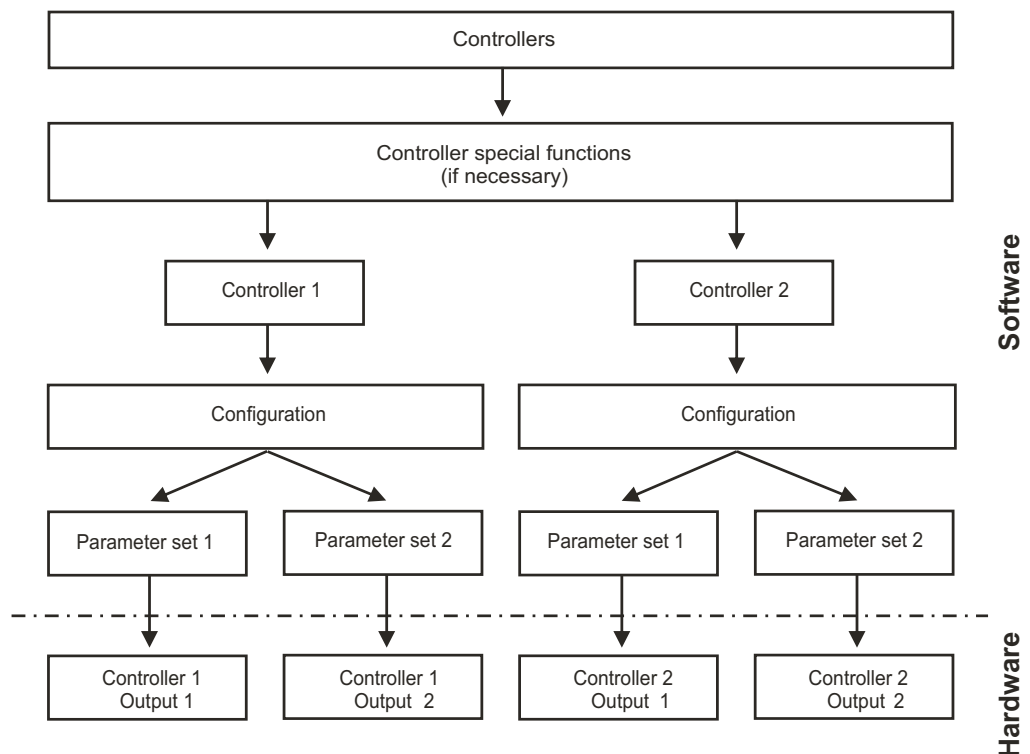

## 11.5 Parameter sets



Different process steps may require different controller settings. The instrument offers the option of creating two parameter sets and then switching between them by means of a binary input.

### Defining a parameter set

ADMINISTR.-LEVEL / PARAMETER LEVEL / CONTROLLER / 1(2) / PARAMETER SET 1(2)

See "Controller" page 109.

### Configuring parameter set switchover

ADMINISTR.-LEVEL / PARAMETER LEVEL / BINARY INPUTS / BINARY INPUT 1(2) / PARAMET. SWITCHOVER

See "Binary inputs" page 109.

# 11 Controller

---

## 11.6 Sample configurations

### 11.6.1 Simple limit monitoring

#### Configuration

##### Limit monitoring

##### Limit value 1

Signal source:	Main value
Switching function:	Alarm function  (AF8)
Switching point:	10.00 Mom x cm
Hysteresis:	0.50 Mom x cm

#### Configuration of binary output, e.g. relay)

##### Binary outputs

##### Binary output 1

Signal source:	Limit monitoring 1
At calibration:	Standard operation
Error:	Inactive
HOLD mode:	Frozen
Turn-on delay:	0 seconds
Turn-off delay:	0 seconds
Wiper time:	0 seconds
Manual mode:	No simulation

### 11.6.2 Limit monitoring to USP

#### Configuration

##### Limit monitoring

##### Limit value 1

Signal source:	Main value
Switching function:	USP
Switching point:	derived automatically from table, See "Excerpt from USP <645>" page 101
Hysteresis	0.50 $\mu$ S/cm

#### Configuration of binary output, e.g. relay)

##### Binary outputs

##### Binary output 1

Signal source:	Limit monitoring 1
At calibration:	Standard operation

Error:	Inactive
HOLD mode:	Frozen
Turn-on delay:	0 seconds
Turn-off delay:	0 seconds
Wiper time:	0 seconds
Manual mode:	No simulation

## 11.6.3 Controller with limit value function

### Configuration of software controllers

#### Controller 1

##### Configuration

Controller type:	Pulse value
Controller actual value:	Main variable
Stroke retransmission:	No signal
Additive disturbance:	No signal
Multiplicative disturbance:	No signal
Min./max. contact:	Max. contact
Inactive/active contact:	Active contact
HOLD mode	0 %
HOLD output:	0 %
Error:	0 %
Alarm control:	Off

##### Parameter set 1

Min. setpoint:	As required
Max. setpoint:	As required
Setpoint:	0.80 mS/cm
Hysteresis:	As required
On-delay:	As required
Delayed release:	As required
Alarm delay:	As required

### Configuration of binary output, e.g. relay)

#### Binary outputs

##### Binary output 1

Signal source:	Controller 1 output 1
----------------	-----------------------

<sup>1</sup> This parameter only appears if "Separate controllers" has been configured in special controller functions.

# 12 Setup program

---

## 12.1 Configurable parameters

Both the setup program (ACM-Soft) and the PC interface cable with USB/TTL converter (ACM-Int) are available as options and provide a convenient way to adapt the transmitter to meet requirements:

- Setting the measuring range.
- Setting the behavior of outputs when the measuring range is exceeded.
- Setting the functions of switching outputs K1 to K8.
- Setting the functions of the binary inputs.
- Setting a customized characteristic
- etc.



Data can only be transferred from or to the transmitter if it is supplied with voltage, See section 5 "Installation", page 14ff.

### Connection

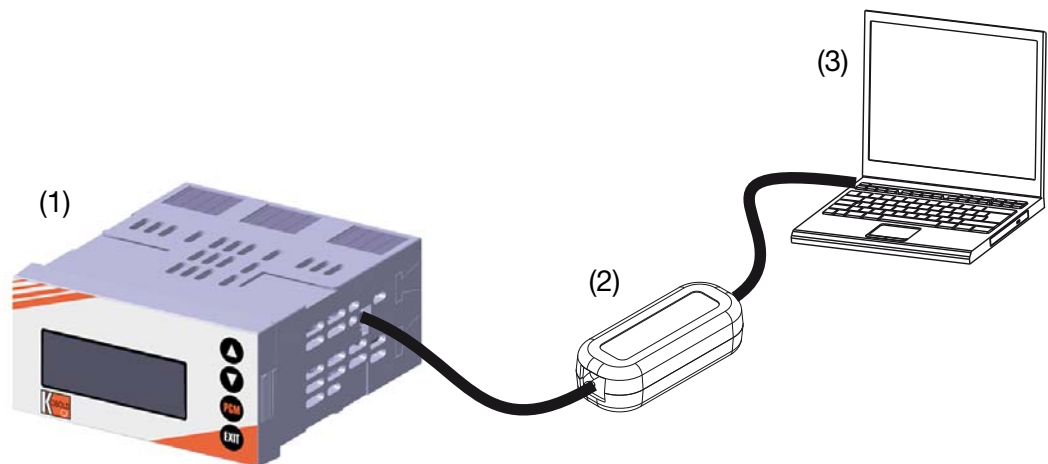

- (1) ACM-1
- (2) PC interface cable with USB/TTL converter,  Sales no.: ACM-Int
- (3) PC or notebook



## 12.2 Documenting the instrument configuration

- \* Start the setup program
  - \* Establish the connection to the instrument (1).
- Read the instrument configuration (2).

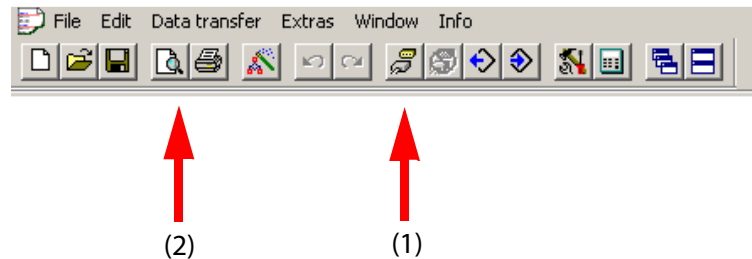

<b>File info header:</b>			
Device name:		Creation date:	10.09.2011
Device SW version:	269.01.jax	Date of change:	10.09.2011
VDN:		Program version:	1.01J
Short info:			
Programmer:			
Type code:			
Job:			
Extra info:			
<b>Hardware / Basic setting:</b>			
Hardware type:			
CR (conductive conductivity)			
Controller			
Variant:			
Default			
Basic setting			
Operating mode:		Conductivity measurement	
Input, range 1:		mS/cm	
Decimal format, range 1:		XXjxx	
2nd measuring range:		OFF	
Cell type:		2 electrodes	
Optionally fitted:			
Not available!			
<b>Analog input, principal value:</b>			
Conductivity CR			
Nominal cell constant:	1.0 1/cm		
Offset MB1:	0.00 mS/cm		
Temperature compensation:	Linear		
Compensation source:	Temperature input		
Reference temperature:	25.0 °C		
Probe break detection:	OFF		
Filter time:	2.0 s		
Calibration interval:	0 Tage		
Supply frequency:	50 Hz		
<b>Analog input: temperature:</b>			
Sensor type:	PT100		
Filter time:	2.0 s		
Manual temperature provision:	25.0 °C		
Offset:	0.0 °C		
<b>Analog input, optional cards:</b>			
No optional analog input card is fitted!			
<b>Binary inputs:</b>			
Binary input 1			
Function:	no function		
Binary input 2			
Programmer:		Document:	
Device name:	477144002	Setup1	
Device SW version:	269.01.jax	Date created:	10.09.2011
Program SW version:	1.01J	Date of change:	10.09.2011
		Page/All pages:	1/7

## 12 Setup program

### 12.3 Special features for "Datalogger"

- \* Start the setup program
- \* Establish the connection to the instrument (1).
- \* Read the instrument configuration (2).

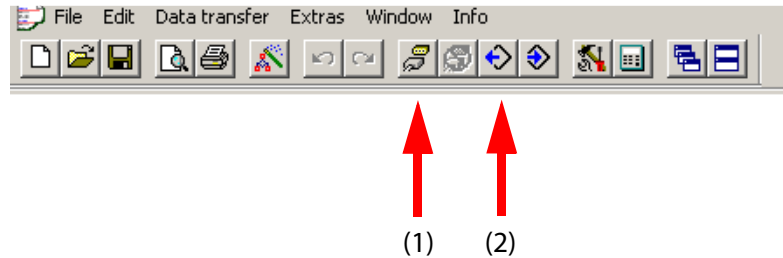

- \* Read data from datalogger (for example table view)
  - Mark datalogger icon (3)
  - Read values from the instrument (4)

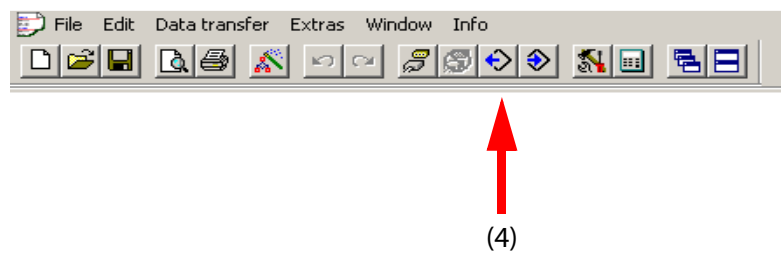
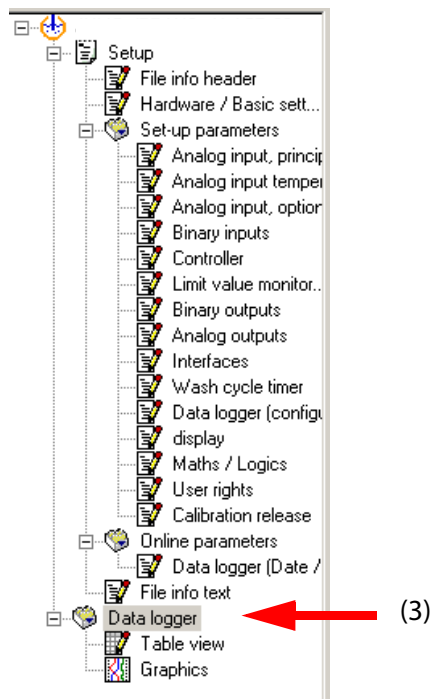

# 12 Setup program

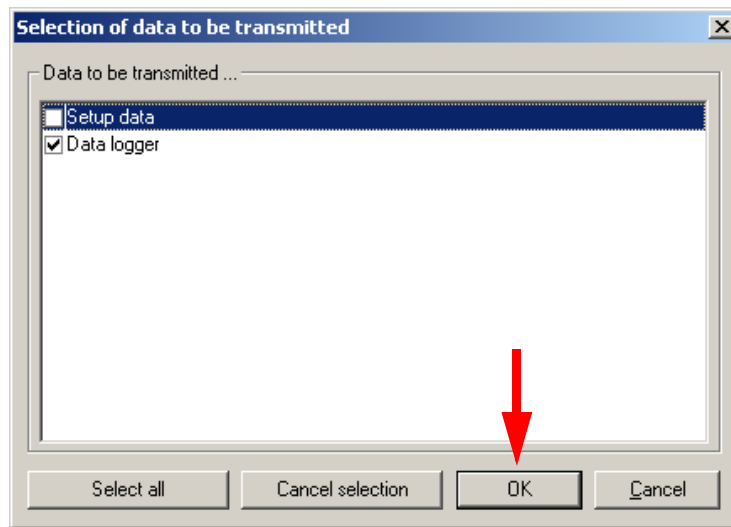

\* Export data (for processing in an external program).



The main interface displays a table of data for "Device ID". A "Data logger: save" dialog box is open over the table, asking for a separator. The table has columns for Date, Time, and various sensor readings.

Date	Time	Analog value 1	Unit 1	Analog value 2	Unit 2	Analog value 3	Unit 3	Analog value 4	Unit 4	Binary output 1	Binary output 2	Binary output 3	Binary output 4	Binary output 5	Binary output 6	Binary output 7	Binary output 8	Binary input 1	Binary input 2	Auto-rotate	Power on	Reverse 2	Reverse 3	Reverse 4	
10.08.2011	13:30:49	1995.779	µS	25	°C	0	%	100	%	0	1	0	0	0	0	0	0	0	0	0	0	0	0	0	0
10.08.2011	13:28:25	1995.779	µS	25	°C	0	%	100	%	0	1	0	0	0	0	0	0	0	0	0	0	0	0	0	0
10.08.2011	13:28:25	1995.779	µS	25	°C	0	%	100	%	0	1	0	0	0	0	0	0	0	0	0	0	0	0	0	0
10.08.2011	13:27:25	1995.779	µS	25	°C	0	%	100	%	0	1	0	0	0	0	0	0	0	0	0	0	0	0	0	0
10.08.2011	13:26:25	1995.779	µS	25	°C	0	%	100	%	0	1	0	0	0	0	0	0	0	0	0	0	0	0	0	0
10.08.2011	13:25:25	1995.779	µS	25	°C	0	%	100	%	0	1	0	0	0	0	0	0	0	0	0	0	0	0	0	0
10.08.2011	13:24:25	1995.779	µS	25	°C	0	%	100	%	0	1	0	0	0	0	0	0	0	0	0	0	0	0	0	0
10.08.2011	13:23:25	1995.779	µS	25	°C	0	%	100	%	0	1	0	0	0	0	0	0	0	0	0	0	0	0	0	0
10.08.2011	13:22:25	1995.779	µS	25	°C	0	%	100	%	0	1	0	0	0	0	0	0	0	0	0	0	0	0	0	0
10.08.2011	13:21:25	1995.779	µS	25	°C	0	%	100	%	0	1	0	0	0	0	0	0	0	0	0	0	0	0	0	0
10.08.2011	13:20:25	1995.779	µS	25	°C	0	%	100	%	0	1	0	0	0	0	0	0	0	0	0	0	0	0	0	0
10.08.2011	13:19:25	1995.779	µS	25	°C	0	%	100	%	0	1	0	0	0	0	0	0	0	0	0	0	0	0	0	0
10.08.2011	13:18:25	1995.779	µS	25	°C	0	%	100	%	0	1	0	0	0	0	0	0	0	0	0	0	0	0	0	0
10.08.2011	13:17:25	1995.779	µS	25	°C	0	%	100	%	0	1	0	0	0	0	0	0	0	0	0	0	0	0	0	0
10.08.2011	13:16:25	1995.779	µS	25	°C	0	%	100	%	0	1	0	0	0	0	0	0	0	0	0	0	0	0	0	0
10.08.2011	13:15:25	1995.779	µS	25	°C	0	%	100	%	0	1	0	0	0	0	0	0	0	0	0	0	0	0	0	0
10.08.2011	13:14:25	1995.779	µS	25	°C	0	%	100	%	0	1	0	0	0	0	0	0	0	0	0	0	0	0	0	0
10.08.2011	13:13:25	1995.779	µS	25	°C	0	%	100	%	0	1	0	0	0	0	0	0	0	0	0	0	0	0	0	0
10.08.2011	13:12:25	1995.779	µS	25	°C	0	%	100	%	0	1	0	0	0	0	0	0	0	0	0	0	0	0	0	0
10.08.2011	13:11:25	1995.779	µS	25	°C	0	%	100	%	0	1	0	0	0	0	0	0	0	0	0	0	0	0	0	0
10.08.2011	13:10:25	1995.779	µS	25	°C	0	%	100	%	0	1	0	0	0	0	0	0	0	0	0	0	0	0	0	0
10.08.2011	13:09:25	1995.779	µS	25	°C	0	%	100	%	0	1	0	0	0	0	0	0	0	0	0	0	0	0	0	0
10.08.2011	13:08:25	1995.779	µS	25	°C	0	%	100	%	0	1	0	0	0	0	0	0	0	0	0	0	0	0	0	0
10.08.2011	13:07:25	1995.779	µS	25	°C	0	%	100	%	0	1	0	0	0	0	0	0	0	0	0	0	0	0	0	0
10.08.2011	13:06:25	1995.779	µS	25	°C	0	%	100	%	0	1	0	0	0	0	0	0	0	0	0	0	0	0	0	0
10.08.2011	13:05:25	1995.779	µS	25	°C	0	%	100	%	0	1	0	0	0	0	0	0	0	0	0	0	0	0	0	0
10.08.2011	13:04:25	1995.779	µS	25	°C	0	%	100	%	0	1	0	0	0	0	0	0	0	0	0	0	0	0	0	0
10.08.2011	13:03:25	1995.779	µS	25	°C	0	%	100	%	0	1	0	0	0	0	0	0	0	0	0	0	0	0	0	0
10.08.2011	13:02:25	1995.779	µS	25	°C	0	%	100	%	0	1	0	0	0	0	0	0	0	0	0	0	0	0	0	0
10.08.2011	13:01:25	1995.779	µS	25	°C	0	%	100	%	0	1	0	0	0	0	0	0	0	0	0	0	0	0	0	0
10.08.2011	13:00:25	1995.779	µS	25	°C	0	%	100	%	0	1	0	0	0	0	0	0	0	0	0	0	0	0	0	0
10.08.2011	12:59:25	1995.779	µS	25	°C	0	%	100	%	0	1	0	0	0	0	0	0	0	0	0	0	0	0	0	0
10.08.2011	12:58:25	1995.779	µS	25	°C	0	%	100	%	0	1	0	0	0	0	0	0	0	0	0	0	0	0	0	0
10.08.2011	12:57:25	1995.779	µS	25	°C	0	%	100	%	0	1	0	0	0	0	0	0	0	0	0	0	0	0	0	0
10.08.2011	12:56:25	1995.779	µS	25	°C	0	%	100	%	0	1	0	0	0	0	0	0	0	0	0	0	0	0	0	0

## 13 Eliminating faults and malfunctions

Problem	Possible cause	Action			
No measurement display or current output	There is no supply voltage	Check the power supply			
Measurement display 0000 or current output 4 mA	Sensor not immersed in medium; level in container too low	Top up the container			
	Flow-through fitting is blocked	Clean the flow-through fitting			
	Sensor faulty	Replace the sensor			
Incorrect or fluctuating measurement display	Sensor faulty	Replace the sensor			
	Sensor positioning incorrect	Choose another installation location			
	Air bubbles	Optimize assembly			
MAIN VALUE INPUT OVERRANGE	Measurement overrange	Choose a suitable measuring range			
MAIN VALUE INPUT UNDERRANGE	Measurement underrange				
<table border="1" style="width: 100%; border-collapse: collapse;"> <tr> <td style="text-align: center;">ALARM</td> </tr> <tr> <td>MEASURING 8888</td> </tr> <tr> <td style="text-align: center;">27.4°C      pH</td> </tr> </table>	ALARM		MEASURING 8888	27.4°C      pH	Main input: Measurement range "out of range"
ALARM					
MEASURING 8888					
27.4°C      pH					
MAIN INPUT COMPENS. RANGE	Compensation range has been left				
TEMPERATURE INPUT OVERRANGE	Measurement overrange	Choose a suitable measuring range			
TEMPERATURE INPUT UNDERRANGE	Measurement underrange				
<table border="1" style="width: 100%; border-collapse: collapse;"> <tr> <td style="text-align: center;">ALARM</td> </tr> <tr> <td>MEASURING 8888</td> </tr> <tr> <td style="text-align: center;">8888 °C      pH</td> </tr> </table>	ALARM		MEASURING 8888	8888 °C      pH	Temperature input: Measurement range "out of range"
ALARM					
MEASURING 8888					
8888 °C      pH					
OPTION INPUT 1. COMPENS. RANGE	Compensation range has been left	Choose a suitable measuring range			
OPTION INPUT 1. OUT OF RANGE	Temperature input: Measurement range "out of range"				
ELECTRODE CONTAMINATED	Coating	Clean electrodes. Replace conductivity cell.			

## 13 Eliminating faults and malfunctions

DEPENDENT PARAMETERS ADJUSTED	Configuration change	OK
DATALOGGER IS DELETED	Configuration change	OK
LEVEL LOCKED	Inhibit via binary contact	Check configuration and unlock if necessary
PARAMETER LOCKED	Do not release	If appropriate release in the release level
WRONG PASSWORD		Test
KEYPAD LOCKED	Inhibit via binary contact	Check configuration and unlock if necessary
CONFIGURATION RE-ESTABLISHED	Cancel in basic setting	OK
ERROR PROFIBUS		Check hardware
UNZULÄSSIGE HARDWARE-BESTÜCKUNG		Check fitting, adjust if necessary
ERROR TIMER TIME RE-ADJUSTMENT	Instrument had no power supply for a very long time	Establish power supply Set the datalogger time

# 14 Technical data

## Inputs (main board)

Main input	Measuring range/control range	Accuracy	Effect of temperature
$\mu\text{S/cm}$	0.000 - 9.999 00.00 - 99.99 000.0 - 999.9 0000 - 9999	$\leq 0.6\%$ of range + $0.3 \mu\text{S} \times \text{cell constant (K)}$	0.2%/10K
$\text{mS/cm}$	0.000 - 9.999 00.00 - 99.99 000.0 - 999.9 0000 - 9999	$\leq 0.6\%$ of range + $0.3 \mu\text{S} \times \text{cell constant (K)}$	0.2%/10K
$\text{k}\Omega \times \text{cm}$	0.000 - 9.999 00.00 - 99.99 000.0 - 999.9 0000 - 9999	$\leq 0.6\%$ of range + $0.3 \mu\text{S} \times \text{cell constant (K)}$	0.2%/10K
$\text{M}\Omega \times \text{cm}$	0.000 - 9.999 00.00 - 99.99 000.0 - 999.9 0000 - 9999	$\leq 0.6\%$ of range + $0.3 \mu\text{S} \times \text{cell constant (K)}$	0.2%/10K
<b>Secondary input</b>			
Temperature Pt100/1000	$-50 - 250^\circ\text{C}^1$	$\leq 0.25\%$ of range	0.2%/10K
Temperature NTC/PTC	0.1 - 30 $\text{k}\Omega$ Entry via table with 20 value pairs	$\leq 1.5\%$ of range	0.2%/10K
<b>Standard signal</b>	0(4) - 20 mA or 0 - 10 V	0.25% of range	0.2%/10K
<b>Resistance transmitter</b>	Minimum: 100 $\Omega$ Maximum: 3 $\text{k}\Omega$	$\pm 5 \Omega$	0.1%/10K

<sup>1</sup> Selectable in °F.

## Resistance thermometer inputs (optional board)

Designation	Connection type	Measuring range	Measuring accuracy		Effect of ambient temperature
			3-wire/4-wire	2-wire	
Pt100 DIN EN 60751 (factory-set)	2-wire/3-wire 4-wire	$-200 - +850^\circ\text{C}$	$\leq 0.05\%$	$\leq 0.4\%$	50 ppm/K
Pt1000 DIN EN 60751 (factory-set)	2-wire/3-wire 4-wire	$-200 - +850^\circ\text{C}$	$\leq 0.1\%$	$\leq 0.2\%$	50 ppm/K
Sensor lead resistance	Maximum 30 $\Omega$ per line with three- and four-wire circuit				
Measurement current	approx. 250 $\mu\text{A}$				
Lead compensation	Not required for three- and four-wire circuit. With a 2-wire circuit, lead resistance can be compensated in the software by correcting the process value.				

## Standard signals inputs (optional board)

Designation	Measuring range	Measuring accuracy	Ambient temperature effect
Voltage	0(2) - 10 V	$\leq 0.05\%$	100 ppm/K
Electrical current	0 - 1 V Input resistance $R_E > 100 \text{ k}\Omega$	$\leq 0.05\%$	100 ppm/K
Resistance transmitter	Minimum: 100 $\Omega$ Maximum: 4 $\text{k}\Omega$	$\pm 4 \Omega$	100 ppm/K

## Temperature compensation

Type of compensation	Range <sup>1</sup>
Linear 0 - 8%/K	$-10 - 160^\circ\text{C}$
ASTM D1125 - 95 (ultra-pure water)	0 - $100^\circ\text{C}$
Natural waters (ISO 7888)	0 - $36^\circ\text{C}$
<b>Reference temperature</b>	
Adjustable from 15 - $30^\circ\text{C}$ ; preset to $25^\circ\text{C}$ (default)	

# 14 Technical data

<sup>1</sup> Note the sensor operating temperature range!

## Measuring circuit monitoring

Inputs	Underrange/ overrange	Short circuit	Broken lead
Conductivity	Yes	Depends on measuring range	Depends on measuring range
Temperature	Yes	Yes	Yes
Voltage	2 - 10 V 2 - 10 V	Yes No	Yes No
Current	4 - 20 mA 0 - 20 mA	Yes No	Yes No
Resistance transmitter	No	No	Yes

## Two-electrode systems

Cell constant [1/cm]	Setting range of the relative cell constant	Resulting usable range [1/cm]
0.01	20 0 500%	0.002 - 0.05
0.1		0.02 - 0.5
1.0		0.2 - 5
3.0		0.6 - 15
10.0		2.0 - 50

## Four-electrode systems

Cell constant [1/cm]	Setting range of the relative cell constant	Resulting usable range [1/cm]
0.5	20 - 150%	0.1 - 0.75
1.0		0.2 - 1.5

## Binary input

<b>Activation</b>	Floating contact is open: function is not active Floating contact is closed: function is active
<b>Function</b>	Key lock, manual mode, HOLD, HOLD inverse, alarm suppression, freeze measured value, level lock, reset partial quantity, reset total quantity, parameter set switchover

## Controller

<b>Controller type</b>	Limit comparators, limit controllers, pulse length controllers, pulse frequency controllers, modulating controllers, continuous controllers
<b>Controller structure</b>	P / PI / PD / PID

## Outputs

Relay (changeover) - Contact rating - Contact service life	PSU board	5 A at 240 VAC resistive load 350,000 operations at nominal load/750,000 operations at 1 A
Supply voltage for 2-wire transmitter	PSU board	Electrically isolated, non-controlled DC 17 V at 20 mA, open-circuit voltage approx. DC 25 V
Power supply for inductive proximity switch	Optional board	DC 12 V; 10 mA
Relay (changeover) - Contact rating - Contact service life	Optional board	8 A at AC 240 V resistive load 100,000 operations at nominal load/350,000 operations at 3A
Relay SPST (normally open) - Contact rating - Contact service life	Optional board	3A at 240VAC resistive load 350,000 operations at nominal load/900,000 operations at 1A

## 14 Technical data

Semiconductor relay - Contact rating - Protective circuit	Optional board	1 A at 240 V Varistor
Semiconductor switch (photo MOS)	Optional board	$U \leq 50 \text{ V AC/DC}$ $I \leq 200 \text{ mA}$
Voltage - Output signals - Load resistance - Accuracy	Optional board	0 - 10 V / 2 - 10 V $R_{\text{load}} \geq 500 \Omega$ $\leq 0.5\%$
Electrical current - Output signals - Load resistance - Accuracy	Optional board	0 - 20 mA / 4 - 20 mA $R_{\text{load}} \leq 500 \Omega$ $\leq 0.5\%$

### Display

Type	LC graphic display, blue with background lighting, 122 x 32 pixels
------	--

### Electrical data

Supply voltage (switch-mode PSU)	AC 110 - 240 V -15/+10%; 48 - 63 Hz or AC/DC 20-30 V; 48 - 63 Hz
Electrical safety	to DIN EN 61010, Part 1 overvoltage category II, pollution degree 2
Power consumption	Max. 13 VA
Data backup	EEPROM
Electrical connection	On the back via screw terminals, conductor cross-section up to max. 2.5 mm <sup>2</sup>
Electromagnetic Compatibility (EMC) - Interference emission - Immunity to interference	DIN EN 61326-1  Class A to industrial requirements

### Enclosure

Enclosure type	Plastic enclosure for panel mounting to DIN IEC 61554, Aluminium field housing, orange
Depth behind panel	90 mm (panel mounting), 137 mm (field housing)
Ambient temperature Storage temperature	-5...+55°C (panel mounting), -5...+50°C (field housing) -30...+70°C
Climatic rating	Rel. humidity $\leq 90\%$ annual mean, no condensation
Operating position	Horizontal
Protection	to DIN EN 60529, front IP65, rear IP20
Weight (fully fitted)	about 380 g (panel mounting), about 1480 g (field housing)

### Interface

<b>Modbus</b>	
Interface type	RS422/RS485
Protocol	Modbus, Modbus Integer
Baud rate	9600, 19200, 38400
Device address	0 - 255
Max. number of nodes	32
<b>PROFIBUS-DP</b>	
Device address	0 - 255



# 15 Retrofitting optional boards



**Caution:**

The instrument **must** be de-energized on the input and output sides!  
Optional boards must only be retrofitted by qualified specialists.





**ESD:**

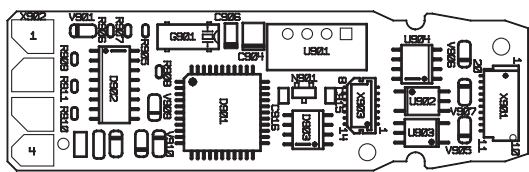
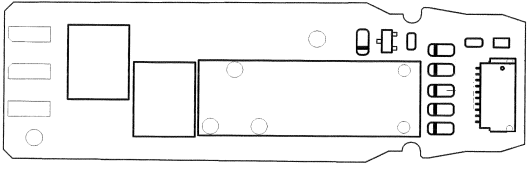
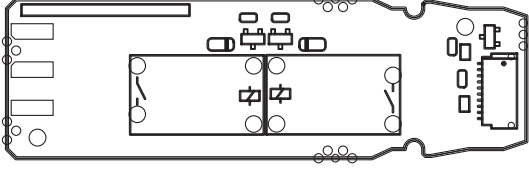
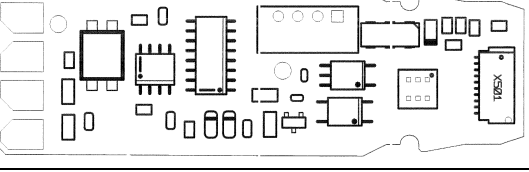

Optional boards can be damaged by electrostatic discharge. You must therefore prevent electrostatic charges from accumulating during installation and removal. Optional boards should be retrofitted at a grounded workstation.

## 15.1 Identifying an optional board

The packaging of the optional board is identified by a sales number.

Optional board	Code	Sales No.	Board view
Analog input (universal)	1	APM-100001	
Relay (1 x changeover)	2	APM-100002	
Relay (2 x NO) This board must <b>only</b> be inserted in optional slot 1 or 3!	3	APM-100003	
Analog output	4	APM-100004	
Two MosFET semiconductor switch	5	APM-100005	

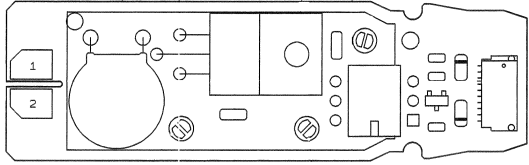
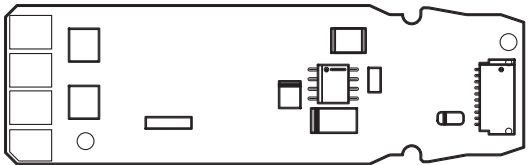
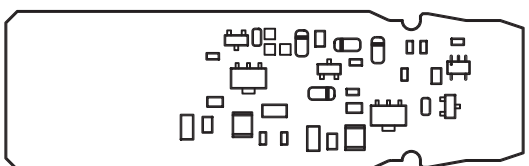
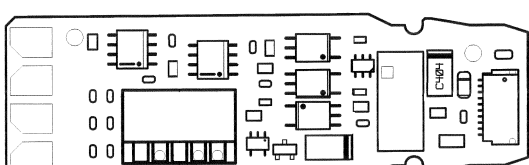
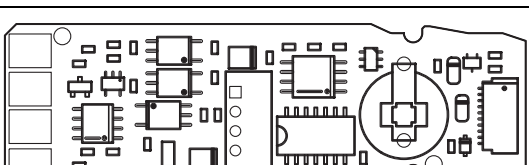
# 15 Retrofitting optional boards

Optional board	Code	Sales No.	Board view
Semiconductor relay 1 A	6	APM-100006	
Supply voltage output +/- 5 V DC (e.g. for ISFET)	7	APM-100007	
Supply voltage output 12 V DC (e.g. for inductive proximity switch)	8	APM-100008	
Interface - RS422/485 This board must <b>only</b> be inserted in optional slot 3!	10	APM-10000S	
Datalogger with interface RS422/485 and real-time clock This board must <b>only</b> be inserted in optional slot 3!	11	APM-10000D	
Profibus-DP interface This board must <b>only</b> be inserted in optional slot 3!	12	APM-10000P	



**Note:**

The optional boards detected by the instrument are displayed in "Device information" (See section 6.5.11 "Device info", page 31).

## 15 Retrofitting optional boards

### 15.2 Removing a plug-in module



- (1) Squeeze the front panel together by the left and right sides and remove the plug-in module.

### 15.3 Inserting a plug-in module



**Caution:**

No "3" relays (2 x SPST/normally open) may be inserted in slot 2!

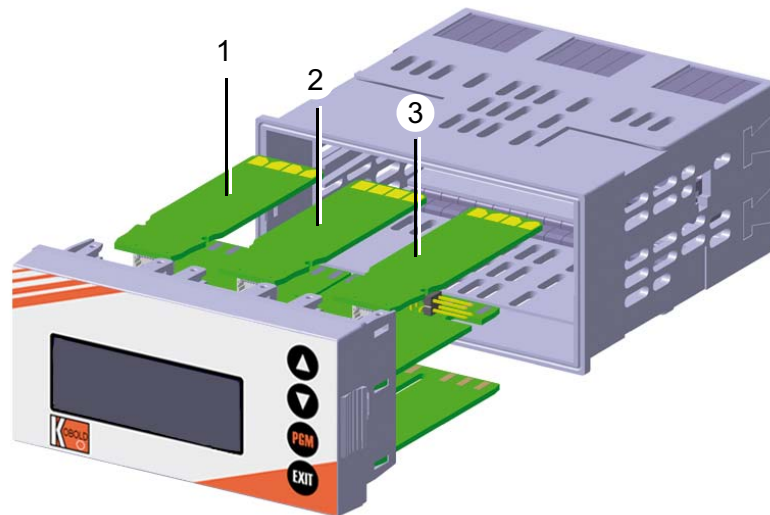

- (1) Slot 1 for optional board
  - (2) Slot 2 for optional board
  - (3) Slot 3 for optional board
- (1) Push the optional board into the slot until it locks in place.
  - (2) Push the device plug-in into the enclosure until it locks in place.

## 15 Retrofitting optional boards

---

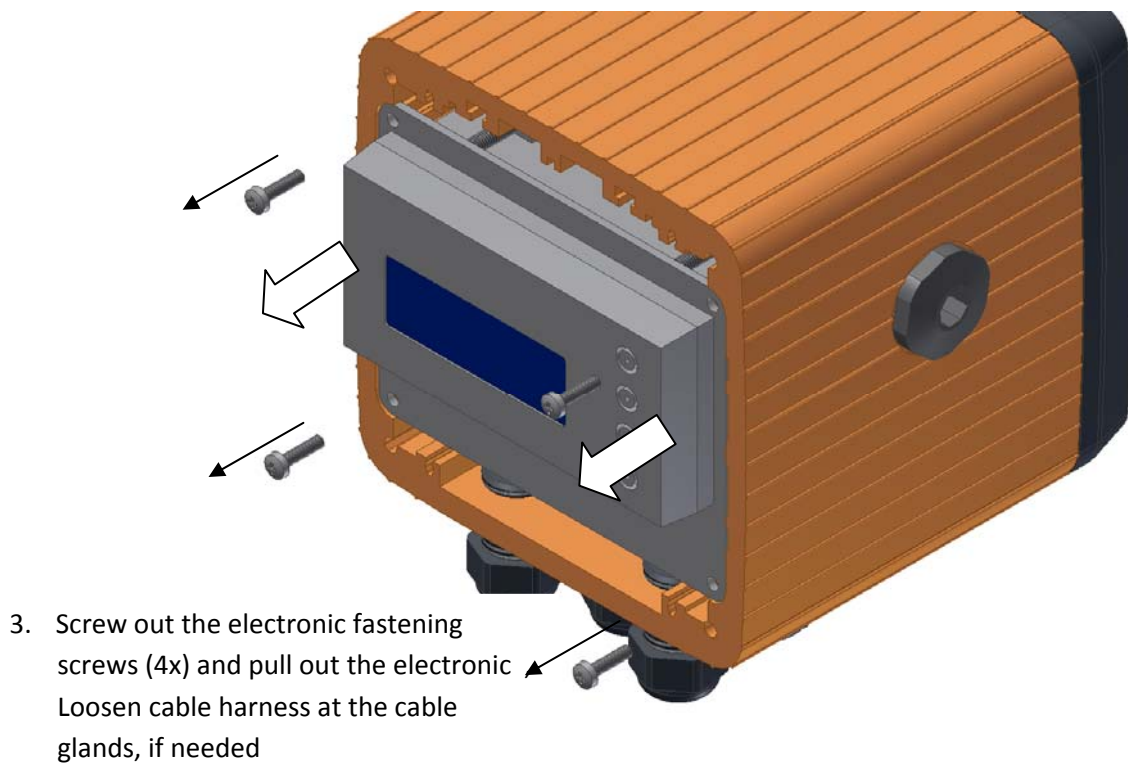

## 15 Retrofitting optional boards

---

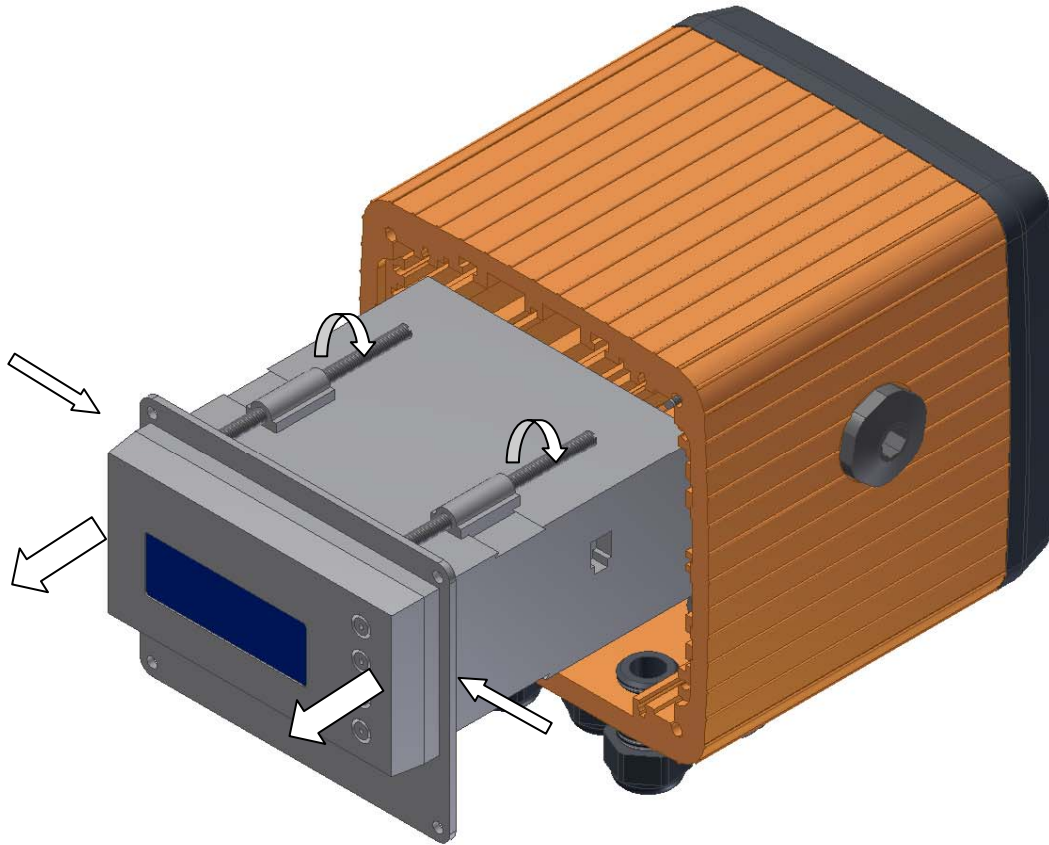

4. Loosen the clamp screws (4x), push back the front plate and press together the latching surface of electronic module from left and right. Pull out the electronic insert from the electronic housing.
5. The optional boards can now be installed in the electronic. The assembly takes place in reverse order. While mounting the front cover on the housing profile, care should be taken to correctly position the gasket in the groove.

# 16 Appendix

## 16.1 Glossary

### Display of measured values STANDARD

The measurement value, measurement variable and temperature of the measuring material are shown in standard display.

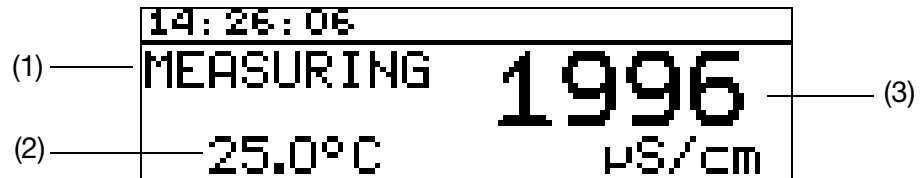

- (1) Operating mode
- (2) Display bottom (temperature input)
- (3) Display top (analog input measurement value)

### Display of measured values TENDENCY

The operator can quickly see the direction in which the measurement is changing.

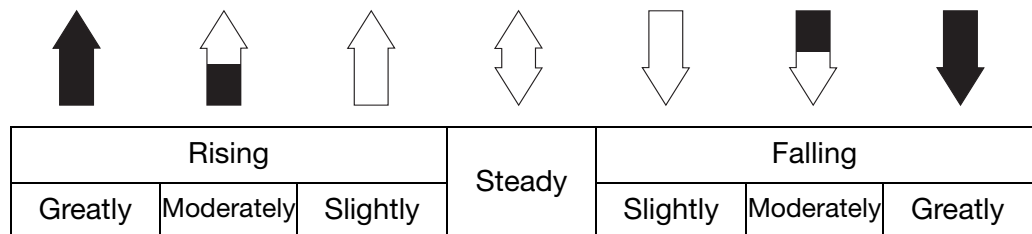
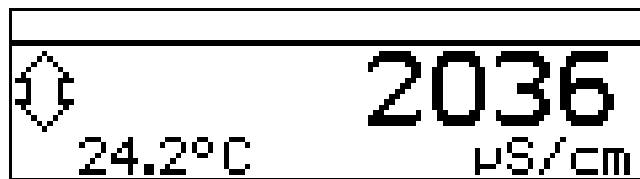

The measurement tendency (trend) is calculated over the last 10 measurement values.







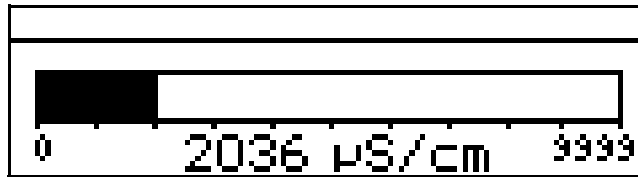

So with a sampling interval of 500 ms, the last 5 seconds are considered.

## Display of measured values BARGRAPH

- Values of the main inputs, input options or math channels (signal source) can be represented as a variable bar (a bar graph).



## Scaling the bar

- \* Activate "BARGRAPH" as the display of measured values.
- \* Select "SCALE START" with .
- \* Confirm the selection with .
- \* Use  and  to enter the lower limit of the range to be displayed.
- \* Confirm the selection with .
- \* Select "SCALE END" with .
- \* Use  or  to enter the upper limit of the range to be displayed.
- \* Confirm the selection with .



To return to Measuring mode:

Press the  key repeatedly or wait for a "timeout".



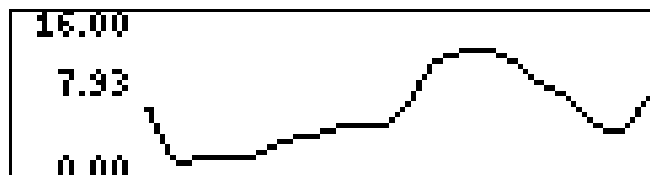

## Display of measured values TREND CHART

Values of the main inputs, input options or math channels (signal source) can be represented as a graph.

The current values appear to the right on the screen.







## Scaling the display

- \* Activate "TREND CHART" as the display of measured values.
- \* Select "SCALE START" with .
- \* Confirm the selection with .
- \* Use  and  to enter the lower limit of the range to be displayed.

## 16 Appendix

---

- \* Confirm the selection with .
- \* Select "SCALE END" with .
- \* Use  or  to enter the upper limit of the range to be displayed.
- \* Confirm the selection with .



To return to Measuring mode:  
Press the  key repeatedly or wait for a "timeout".

---

### Display of measured values LARGE DISPLAY

Values of the main inputs, input options or math channels (signal source) can be displayed in large format.

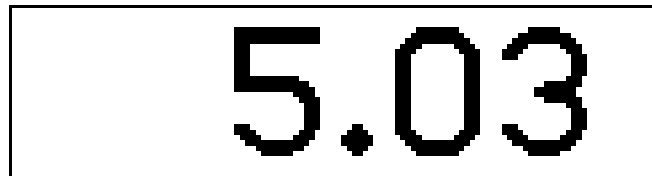

5.03

### Display of measured values 3 MEAS. VALUES

Three values of the main inputs, input options or math channels (signal source) can be displayed simultaneously.

The position of the value to be displayed can be set to "Top", "Center" or "Bottom".

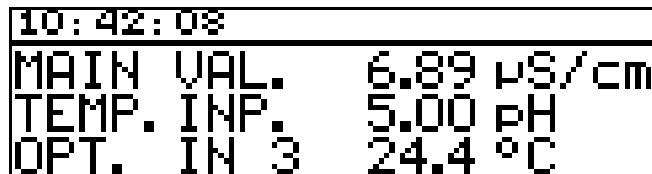

10:42:08	
MAIN VAL.	6.89 $\mu\text{S}/\text{cm}$
TEMP. INP.	5.00 pH
OPT. IN 3	24.4 $^{\circ}\text{C}$

### Relative cell constant

Mechanical or chemical effects can change the electrical properties of a conductivity cell. This will result in a measurement error. This deviation (and thus the measurement error as well) can be compensated for by adjusting the relative cell constant in the transmitter. The relative cell constant defines the deviation of the actual cell constant of the measuring cell from its nominal value.



## Zero point (1-point) calibration

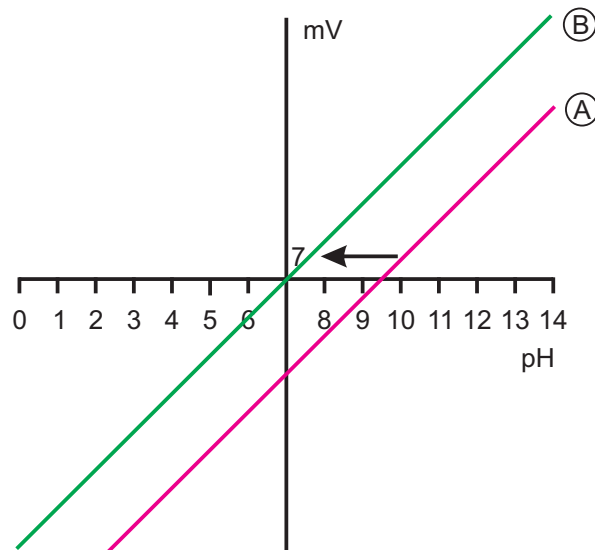

- With one-point offset calibration, the zero point of the pH combination electrode is calculated, See section 8.4 "Calibrating the relative cell constant", page 51.  
Recommended only for special applications, such as ultra-pure water.

## 2-point calibration

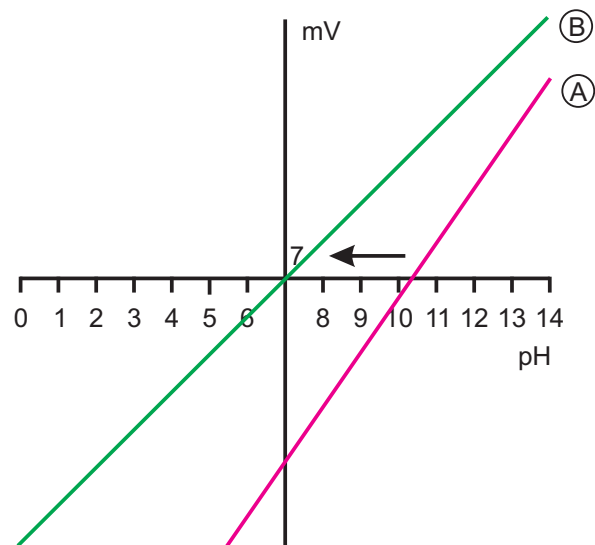

- With two-point calibration, the zero point and slope of the combination electrode are calibrated.  
This is the recommended calibration for most sensors.

## Temperature compensation (conductivity or resistance)

The conductivity of a measurement solution is temperature-dependent (the conductivity of a solution rises as the temperature increases). The dependency of conductivity and temperature describes the **temperature coefficient** of the measurement solution. As conductivity is not always measured for the reference temperature, automatic temperature compensation is integrated in

## 16 Appendix

---

this instrument. The transmitter uses the temperature coefficient to calculate the conductivity that would exist for a reference temperature from the current conductivity and the current temperature. This is then displayed. This process is called temperature compensation. Modern transmitters offer different ways to perform this temperature compensation.

- Linear compensation (constant temperature coefficient).  
This type of compensation can be applied to many kinds of normal water, with acceptable accuracy. The temperature coefficient used is then approx. 2.2%/°C
- Natural water (EN27888 or ISO 7888).  
In this case, so-called non-linear temperature compensation is used. According to the standard cited above, the relevant type of compensation can be applied to natural groundwater, spring water and surface water. The definition range for the water temperature is as follows:  
 $0^{\circ}\text{C} \leq T < 36^{\circ}\text{C}$   
Conductivity of the water is compensated in the range from 0°C to 36°C.
- ASTM1125-95.  
This type of temperature compensation is used in measurements of ultra-pure water. The highly non-linear nature of the temperature dependency for neutral, acidic and alkaline impurities is taken into consideration in accordance with the standard.  
The definition range for the water temperature is as follows:  
 $0^{\circ}\text{C} < T < 100^{\circ}\text{C}$ .  
Conductivity of the water is compensated in the range from 0°C to 100°C.

### Temperature compensation (pH or ammonia)

The pH value of a measurement solution depends on the temperature. Since the pH value is not always measured at the reference temperature, the instrument is able to perform a temperature compensation.

The sensor signal for the ammonia measurement is temperature-dependent. The instrument can perform temperature compensation.







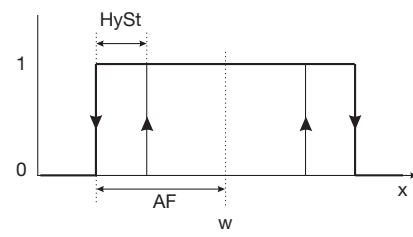

---

The redox potential of a measurement solution is **not** temperature-dependent! Temperature compensation is not required.

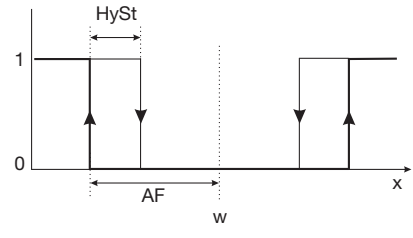
---

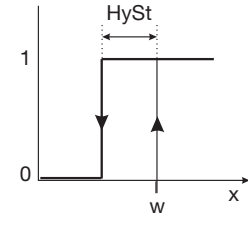
## Limit value (alarm) function of the binary outputs

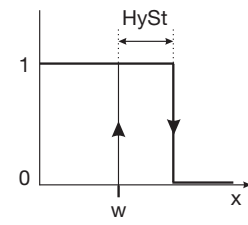
	AF1	
	AF2	
	AF7	
	AF8	

## Pulse length controller (output active with $x > w$ and P control structure)

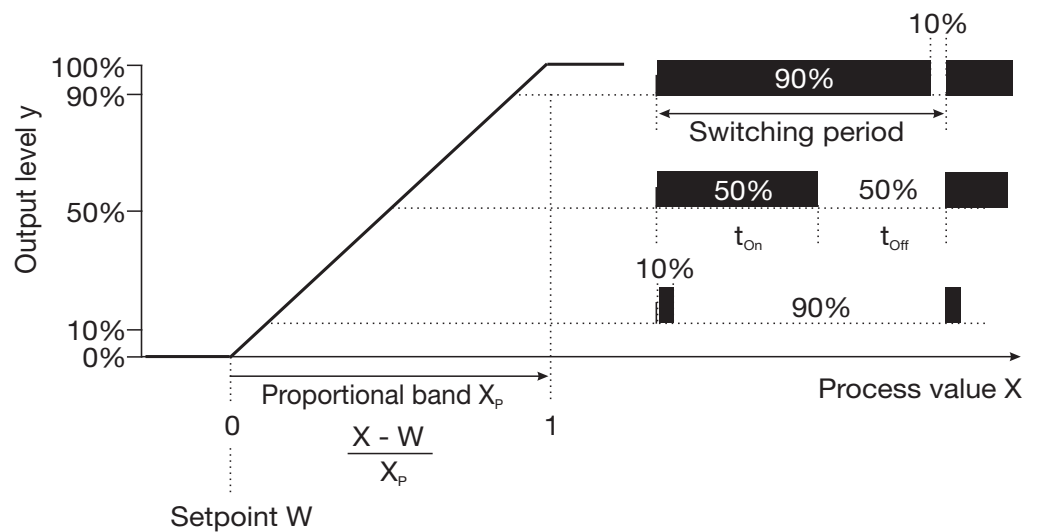

If actual value  $x$  exceeds setpoint  $W$ , the P controller will control in proportion

## 16 Appendix

---

to the control deviation. When the proportional range is exceeded, the controller operates with an output level of 100% (100% clock ratio).

### Pulse frequency controller (output active with $x > w$ and P control structure)

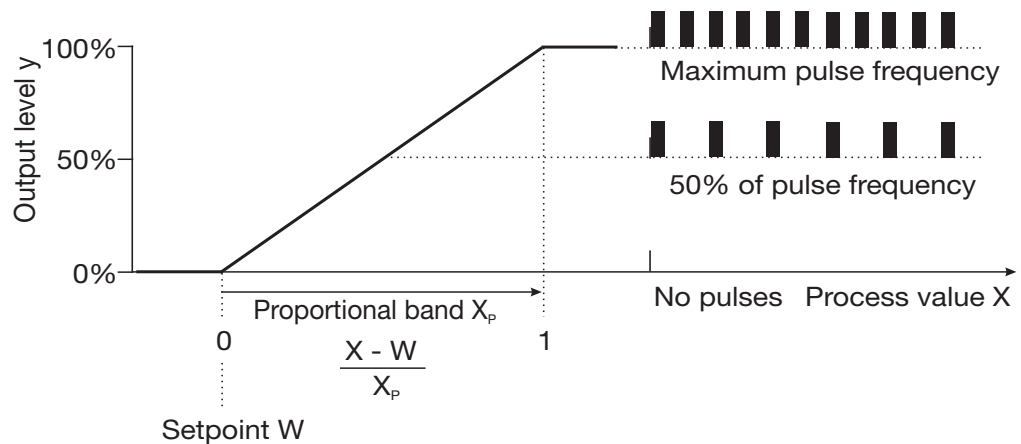

If actual value  $x$  exceeds setpoint  $W$ , the P controller will control in proportion to the control deviation. When the proportional range is exceeded, the controller operates with an output level of 100% (maximum switching frequency).

### Special controller functions: Separate controllers

This function is normally deactivated (factory setting or select "No").

In the deactivated state, the software prevents the two controller outputs from being able to work "against each other". So, for example, it is not possible to dose acid and lye at the same time.

If the controllers are separate ("Yes" selection), each controller can be freely configured.

### Switch-off of the I-component

This function is normally deactivated (factory setting or select "No").

In the deactivated state, the controller works in accordance with general controller theory.

When I-component switch-off is activated ("Yes" selection), the part of the output level that can be traced back to the I-component is set to zero when the setpoint is reached.

This can be useful with mutual neutralization (acid and lye dosing both possible) in one treatment tank.

### Calibration timer

The calibration timer indicates (on request) a required routine calibration. The calibration timer is activated by entering the number of days that must expire before there is a scheduled re-calibration (specified by the system or the operator).

### Wash timer

The wash timer can be used to implement automated sensor cleaning. To do this, the function is assigned to a switching output.

The cycle time (cleaning interval) can be adjusted in the range from 0.0 to 240.0 hours.

A cycle time of "0.0" means the wash timer is deactivated.

The wash time (cleaning duration) is adjustable from 1 to 1800 seconds.

During the wash time the controller goes into the HOLD state, which is maintained for 10 seconds after completion of the wash time. A sensor calibration within the cycle time restarts the wash timer.

### USP contact (for ultra-pure water)

The USP contact makes it possible to monitor the quality of ultra-pure water according to the requirements of USP <645>. USP <645> contains a table that assigns a limit value for conductivity depending on the temperature. If the conductivity stays below this limit value, the ultra-pure water meets the requirements of USP <645>.

If the conductivity of the water is greater than what is specified in the USP table for a given temperature, the USP contact switches the instrument.

Limit values are defined in levels. For example, a value of 5°C is used at 8°C.

#### Note:

During monitoring, temperature compensation must be turned off (temperature coefficient = 0)!

To do this, select Administrator Level / Basic Setting / Temperature Compensation / None.

### Excerpt from USP <645>

Temperature °C	Max. conductivity µS/cm (uncompensated)	Temperature °C	Max. conductivity µS/cm (uncompensated)
0	0.6	55	2.1
5	0.8	60	2.2
10	0.9	65	2.4
15	1.0	70	2.5
20	1.1	75	2.7
25	1.3	80	2.7
30	1.4	85	2.7
35	1.5	90	2.7
40	1.7	95	2.9
45	1.8	100	3.1
50	1.9		

If the conductivity is exceeded at the relevant temperature, the configured contact switches.

### USP warning alarm

The USP warning alarm switches before the water quality reaches the set limit value.

This parameter (0 - 100) is used to set the distance as a percentage (relative to the active limit value) to be maintained from the USP limit.

## 16 Appendix

---

### Ultra-pure water per Ph. Eur.

The limit comparators of the instrument switch, depending on the corresponding configuration, according to the limit valued of the European Pharmacopeia (Ph. Eur.) for purified water.

Temperature °C	Max. conductivity µS/cm
0	0.6
10	0.9
15	1.0
20	1.1
25	1.3
30	1.4
35	1.5
40	1.7
45	1.8
50	1.9

### Ph. Eur. warning alarm

The Ph. Eur. warning alarm switches before the water quality reaches the set limit value.

This parameter (0 - 100) is used to set the distance as a percentage (relative to the active limit value) to be maintained from the USP limit.

### TDS

Display/control with the unit ppm.

The specific TDS factor can also be entered in this mode.

**TDS** (Total **D**issolved **S**olids, also commonly referred to in Germany as filtrate dry residue (Filtratrockenrückstand).

This value is important in areas such as groundwater analysis and power plants.

The value is also used in evaluating drinking water quality (for example in the USA, Arab and Asian countries).

Various organizations have published limit values on this topic.

- WHO (**W**orld **H**ealth **O**rganization) <1000mg/l
- USEPA (**U**nited **S**tates **E**nvironmental **P**rotection **A**gency) <500mg/l

Standardized determination is performed gravimetrically, i.e.:

- Filter sample
- Evaporate filtrate
- Weigh residue

A conductivity measurement is used for the online measurement. A single time is sufficient to determine the conversion factor. It corresponds to the ratio of the conductivity value of the water to the value of the gravimetrically determined filtrate dry residue (TDS). The factor moves within the range from 0.55 to 1.0. A typical value for drinking water is about 0.67.

With modern instruments, this factor can be entered individually to achieve the most accurate measurement possible.

## Customer specs. table

In this mode, the input value can be displayed based on a table (max. 20 value pairs). This function is used to display and linearize non-linear input variables. Values can only be entered in the table using the optional setup program.

## Cust. specs. characteristic

In this mode, the instrument can model a monotonically increasing input variable to any output value.

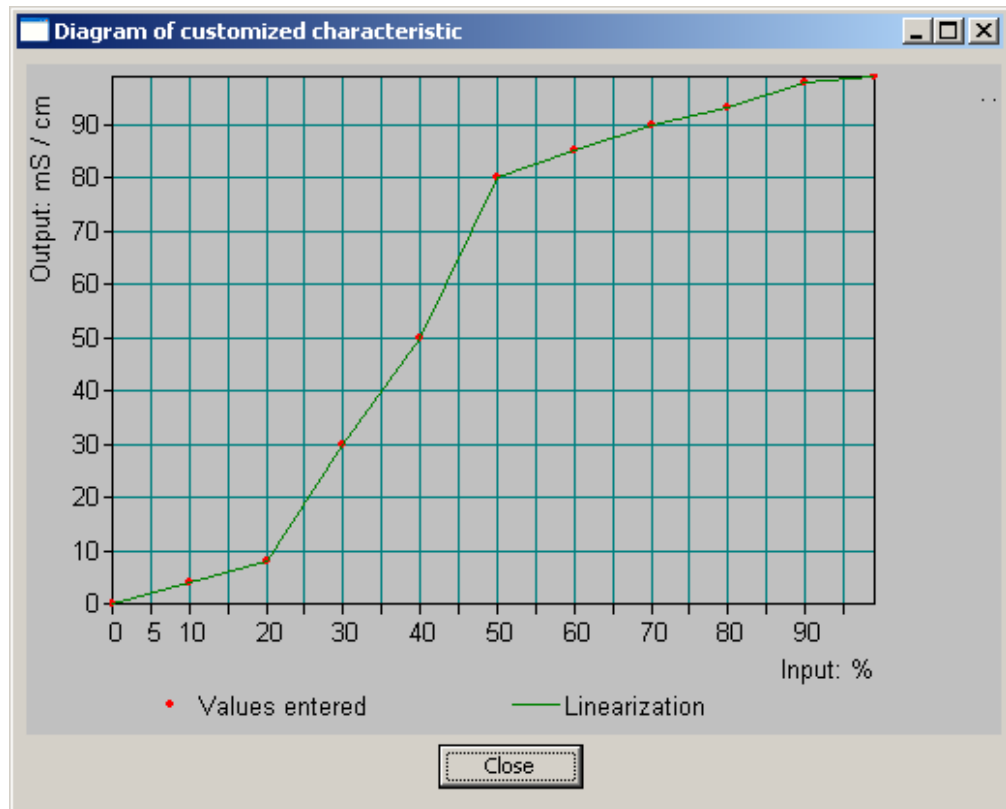

The optional setup program is used to enter the requisite value table.

	Input	Output
1	0.00	0.0000
2	10.00	4.0000
3	20.00	8.0000
4	30.00	30.0000
5	40.00	50.0000
6	50.00	80.0000
7	60.00	85.0000
8	70.00	90.0000
9	80.00	93.0000
10	90.00	98.0000
11	99.00	99.0000
12		
13		
14		

Note  
 With the customized table, you can enter a maximum of 20 interpolation points in the table.  
 Value range, input variable: 0.00 ... 100.00 %  
 Value range, output variable: -99.9900 ... 99.9900 mS / cm  
 Please note that the input variables must be ascending.

## Min./max. value memory

# 16 Appendix

---

This storage records the minimum and maximum input quantities that have occurred. This information can be used, for example, to assess whether the design of the connected sensor is suitable for the values that actually occur.

The max./min. value memory can be reset,  
See section 6.7.6 "Delete min/max values", page 35:

## Datalogger

Recording duration = about 10 hours with a storage interval of 1 second

Recording duration = about 150 days with a storage interval of 300 seconds

## Range switchover

In some processes it is advantageous to have two measurement ranges available, for example in rinsing and regeneration processes.

Normally in these processes a low conductivity must be recorded. In the case of rinsing / regeneration, however, the conductivity is significantly higher, which would result in measurement overrange (error). This situation is not only unsatisfactory, it could also be dangerous.

---

When range switchover is activated, the parameter set is switched as well!

---



When range switchover is activated, two copies of the following parameters are present:

- Relative cell constant
  - Offset
  - Temperature compensation
  - Temperature coefficient
- 

### - Autorange

The Autorange function can be used to define two measurement ranges between which the instrument switches in a defined manner.

### - Manual

Switching is initiated in this function mode by a binary input.

---



Autorange is only configurable for units mS/cm and  $\mu$ S/cm.

Measurement range 1 must be smaller than measurement range 2.

Control only occurs in measurement range 1.

The actual value output in measurement range 2 is scaled to the full display scope.

Switching from measurement range 1 to measurement range 2 occurs when display range 1 is exceeded. The display jumps back when the actual value falls below 90% of display range 1.

A binary output can indicate switching from one measurement range to the other.

---

## Parameter set switchover

---



In some processes (different process steps) it is advantageous to have two complete parameter sets available.

Define the parameter sets See section 11.5 "Parameter sets", page 77.

The predefined parameter sets are activated by a binary input.

### **Deposit detection**

Deposit detection can be activated for four-electrode cells.

It may happen during normal operation that a coating forms on the electrodes. Because of this, the conductivity that is displayed is lower than the actual conductivity. When the "Deposit detection" function is activated, cell maintenance is required.

# 16 Appendix

## 16.2 Parameters of the User level

When there are numerous instrument parameters to configure, it is advisable to make a note in the table below of all the parameters to be changed and to work through these parameters in the given order.



The following list shows the maximum number of parameters that can be modified.

Some of these parameters will not be visible (and therefore not editable) for your particular instrument, depending on the configuration.

Parameter	Selection / value range <b>Factory setting</b>	New setting
<b>Conductivity input</b>		
Cell constant	0.01 / 0.1 / 0.5 / <b>1.0</b> / 3.0 / 10.0	
Relative cell constant and Relative cell constant MB 2	20.0 - <b>100.0</b> - 500.0	
Offset and offset MB 2	-20.00 - <b>0.00</b> - 20.00% of the display range	
Temperature compensation and temperature compensation MB 2	None <b>Linear</b> Natural waters ASTM 1125 neutral ASTM 1125 acidic ASTM 1125 alkaline	
Temperature compensation source	<b>Temperature input</b> Option input 1 Option input 2 Option input 3 Manual temperature input	
Temperature coefficient and temperature coefficient MB 2	0.00 - <b>2.20</b> - 8.00%/K	
Reference temperature	15.0 - <b>25.0</b> - 35.0°C	
Pollution recognition	<b>Off</b> On	
Broken sensor detection	<b>Off</b> On	
Filter time constant	0.0 - <b>2.0</b> - 25.0 seconds	
Calibration interval	<b>0</b> - 99 days (0 = timer not active)	

Parameter	Selection / value range <b>Factory setting</b>	New setting
Differential measurement	<b>Off</b> Main input - (minus) Option input 1 Main input - (minus) Option input 2 Main input - (minus) Option input 3 Option input 1 - (minus) Main input Option input 2 - (minus) Main input Option input 3 - (minus) Main input	
Supply frequency	<b>50 Hz</b> 60 Hz	
<b>Temperature input</b>		
Temperature sensor	No sensor <b>Pt 100</b> Pt 1000 Cust. specs. 0 - 20 mA 4 - 20 mA 0 - 10 V 2 - 10 V Resistance transmitter	
Unit	<b>°C/°F</b> % Without unit Cust. specs.	
Scaling start	-100.0 - <b>0.0</b> - 499.9°C	
Scaling end	-99.9 - <b>100.0</b> - 500.0°C	
Filter time constant	0.0 - <b>2.0</b> - 25.0 seconds	
Manual temperature	-99.9 - <b>25.0</b> - +99.9°C	
Offset	-99.9 - <b>0.0</b> - +99.9°C	
<b>Optional inputs</b>		
<b>Analog inputs 1 to 3</b>		
Operating mode	<b>Off</b> Linear Temperature pH measurement Conductivity Concentration Cust. specs. Stroke feedback Chlorine, pH-compensated	
Signal type	<b>0 - 20 mA</b> 4 - 20 mA 0 - 10 V 2 - 10 V 0 - 1 V Pt100 Pt1000 Cust. specs.	

## 16 Appendix

Parameter	Selection / value range <b>Factory setting</b>	New setting
Connection type	<b>2-wire</b> 3-wire 4-wire	
Display format	XXXX XXX.x <b>XX.xx</b> X.xxx	
Unit	µS/cm mS/cm kΩ*cm MΩ*cm None Cust. specs. mV <b>pH</b> % ppm mg/l	
Scaling start	<b>-9999</b> - +9998	
Scaling end	-9998 - <b>+9999</b>	
Temperature compensation source	<b>Temperature input</b> Option input 1 Option input 2 Option input 3 Manual temperature	
pH compensation source	<b>Main input</b> Option input 1 Option input 2 Option input 3	
Temperature compensation	None <b>Linear</b> TC graph Natural waters ASTM D1125 neutral ASTM D1125 acidic ASTM D1125 alkaline NaOH 0 - 12% NaOH 25 - 50% HNO <sub>3</sub> 0 - 25% HNO <sub>3</sub> 36 - 82% H <sub>2</sub> SO <sub>4</sub> 0 - 28% H <sub>2</sub> SO <sub>4</sub> 36 - 85% H <sub>2</sub> SO <sub>4</sub> 92 - 99% HCl 0 - 18% HCl 22 - 44%	
Reference temperature	15.0 - <b>25.0</b> - 30.0°C	
Filter time constant	0.0 - <b>2.0</b> - 25.0 seconds	
Relative cell constant	20.0 - <b>100.0</b> - 500.0 1/cm	
Temperature coefficient	0.00 - <b>2.20</b> - 8.00 1/cm	

Parameter	Selection / value range <b>Factory setting</b>	New setting
Zero point	-9999 - <b>0</b> - +9999	
Slope	-999.9 - <b>100.0</b> - +999.9%	
<b>Binary inputs</b>		
<b>Binary input 1 or 2</b>		
Function	No function Manual mode Hold mode Hold mode inverse Alarm stop Freeze measured value Key lock Lock levels Flow rate measurement Reset day counter Reset total counter Range switchover	
<b>Controller</b>		
<b>Controller 1 or 2</b>		
Parameter set 1 or 2		
Min. setpoint	<b>0</b> - 9999	
Max. setpoint	0 - <b>9999</b>	
Setpoint	<b>0</b> - 9999	
Setpoint 2	<b>0</b> - 9999	
Proportional range	<b>0</b> - 9999	
Reset time	<b>0.00</b> - 9999 s	
Derivative time	<b>0.00</b> - 9999 s	
Period time	2.00 - <b>60.0</b> - 999.9 s	
Hysteresis	0 - <b>200</b> - 9999	
On-delay	<b>0.00</b> - 999.5 s	
Delayed release	<b>0.00</b> - 999.5 s	
Output limit	<b>0</b> - 100%	
Min. turn-on time	0.20 - <b>0.50</b> - 99.50 s	
Actuator time	10 - <b>60</b> - 3000 s	
Max. pulse frequency	1 - <b>60</b> - 80 1/s	
Alarm tolerance	0.00 - <b>1.00</b> - 16.00	
Alarm delay	<b>0.00</b> - 9999 s	
<b>Configuration</b>		
Controller type	<b>Off</b> Limit value Pulse lengths Pulse frequency Continuous Modulating	





## 16 Appendix

Parameter	Selection / value range <b>Factory setting</b>	New setting
Controller actual value	<b>Main value</b> Not comp. Main value Temperature Option input 1 Option input 1 not compensated Option input 2 Option input 2 not compensated Option input 3 Option input 3 not compensated Math 1 Math 2 Differential signal	
Stroke retransmission	No signal <b>Main value</b> Not comp. Main value Temperature Option input 1 Option input 1 not compensated Option input 2 Option input 2 not compensated Option input 3 Option input 3 not compensated Math 1 Math 2	
Additive disturbance	No signal <b>Main value</b> Not comp. Main value Temperature Option input 1 Option input 1 not compensated Option input 2 Option input 2 not compensated Option input 3 Option input 3 not compensated Math 1 Math 2	

<sup>1</sup> Delayed release is automatically deactivated when wiper times are greater than 0 seconds.

Parameter	Selection / value range <b>Factory setting</b>	New setting
Multiplicative disturbance	No signal <b>Main value</b> Not comp. Main value Temperature Option input 1 Option input 1 not compensated Option input 2 Option input 2 not compensated Option input 3 Option input 3 not compensated Math 1 Math 2	
Min/max contact	<b>Min contact</b> Max contact	
Make/break contact	Make contact <b>Break contact</b>	
Hold mode	<b>0%</b> 100% Frozen Hold output	
Hold reg. ratio	<b>0 - 100%</b>	
Error	<b>0%</b> 100% Frozen Hold output	
Alarm control	<b>Off</b> On	
<b>Controller special functions</b>		
I-switch-off	<b>Inactive</b> (the controller is working normally) Active (special behavior)	
Separate controllers	<b>No</b> Yes	
Manual mode	<b>Locked</b> Coding Switching	
<b>Limit value control</b>		
<b>Limit values 1 to 4</b>		

# 16 Appendix

Parameter	Selection / value range <b>Factory setting</b>	New setting
Signal source	<b>No signal</b> Main value Not comp. Main value Temperature Option input 1 Option input 1 not compensated Option input 2 Option input 2 not compensated Option input 3 Option input 3 not compensated Math 1 Math 2 Differential signal Flow rate Partial quantity Total quantity Output controller 1 Output controller 2 Setpoint 1 controller 1 Setpoint 2 controller 1 Setpoint 1 controller 2 Setpoint 2 controller 2	
Switching function	Alarm function  (AF1) Alarm function  (AF2) Alarm function  (AF7) Alarm function  (AF8)	
Switching point	<b>0</b> - 9999	
Hysteresis	<b>0</b> - 9999	
<b>Binary outputs</b>		
<b>Binary outputs 1 to 8</b>		



Parameter	Selection / value range <b>Factory setting</b>	New setting
Signal source	<b>No signal</b> Limit value control 1 Limit value control 2 Limit value control 3 Limit value control 4 Controller 1 output 1 Controller 1 output 2 Controller 2 output 1 Controller 2 output 2 Controller alarm 1 Controller alarm 2 Controller alarm Sensor warnings Sensor error Warnings and errors Calibration timer Wash timer Logic 1 Logic 2 Autorange	
At calibration	<b>Standard operation</b> Inactive Active Frozen	
Error	<b>Inactive</b> Active Frozen	
Hold mode	<b>Inactive</b> Active Frozen Standard operation	
Switch-on delay	<b>0.0</b> - 3600 s	
Switch-off delay	<b>0.0</b> - 3600 s	
Pulse time <sup>1</sup>	<b>0.0</b> - 3600 s	
Manual mode	<b>No simulation</b> Inactive Active	
<b>Analog outputs</b>		
<b>Analog outputs 1 to 3</b>		

## 16 Appendix

Parameter	Selection / value range <b>Factory setting</b>	New setting
Signal source	No signal <b>Main value</b> Not comp. Main value Temperature Option input 1 Option input 1 not compensated Option input 2 Option input 2 not compensated Option input 3 Option input 3 not compensated Math 1 Math 2 Differential signal Flow rate Partial quantity Total quantity Output controller 1 Output controller 2 Setpoint 1 controller 1 Setpoint 2 controller 1 Setpoint 1 controller 2 Setpoint 2 controller 2	
Signal type	<b>0 - 20 mA</b> 4 - 20 mA 20 - 0 mA 20 - 4 mA 0 - 10 V 10 - 0 V	
Scaling start	<b>0 - 9999</b>	
Scaling end	<b>0 - 9999</b>	
At calibration	<b>Moving</b> Frozen Safe value	
In case of error (output signal, of the controller in case of error)	<b>0/4 mA / 0 V</b> 20 mA / 10 V Frozen Safety value	
Hold mode (output signal, of the controller in Hold mode)	<b>Frozen</b> Safety value Standard mode 0/4 mA / 0 V 20 mA / 10 V	
Safety value	<b>0.0 - 20.0 mA</b>	
Simulation	<b>Off</b> On	
Simulation value	Off <b>0.0 - 20.0 mA</b>	
<b>Interface</b>		
Modbus address	<b>1 - 254</b>	

Parameter	Selection / value range <b>Factory setting</b>	New setting
Baud rate	<b>9600</b> 19200 38400	
Parity	<b>None</b> Even Odd	
Stop bits	<b>1</b> 2	
Profibus address	<b>0</b> - 99	
EEPROM marking	<b>Off</b> On	
<b>Wash timer</b>		
Cycle time	<b>0.0</b> - 240.0 hours (0.0 = Wash contact is not active)	
Wash time	1 - <b>60</b> - 1800 seconds	
<b>Datalogger</b>		
Storage interval	1 - <b>60</b> - 300 seconds	
Channels 1 to 4	No signal <b>Main value</b> (standard for channel 1) Not comp. Main value <b>Temperature</b> (standard for channel 2) Option input 1 Option input 1 not compensated Option input 2 Option input 2 not compensated Option input 3 Option input 3 not compensated Math 1 Math 2 Differential signal Flow rate Partial quantity Total quantity <b>Output controller 1</b> (standard for channel 3) <b>Output controller 2</b> (standard for channel 4) Setpoint 1 controller 1 Setpoint 2 controller 1 Setpoint 1 controller 2 Setpoint 2 controller 2	
Date year	<b>20xx</b>	
Date month	<b>1</b> - 12	
Date day	<b>1</b> - 31	
Time hour	<b>0</b> - 24	
Time minute	<b>0</b> - 59	
Time second	<b>0</b> - 59	
<b>Display</b>		

## 16 Appendix

Parameter	Selection / value range <b>Factory setting</b>	New setting
Lighting	<b>On</b> With operation	
Display of measured value	Standard Tendency Bargraph Trend chart Large display 3 measured values Time	
Display Top / Center / Bottom	No signal <b>Main value</b> (standard for "Top") Not comp. Main value <b>Temperature</b> (standard for "Center" and "Bottom") Option input 1 Option input 1 not compensated Option input 2 Option input 2 not compensated Option input 3 Option input 3 not compensated Math 1 Math 2 Differential signal Flow rate Partial quantity Total quantity Output controller 1 Output controller 2 Setpoint 1 controller 1 Setpoint 2 controller 1 Setpoint 1 controller 2 Setpoint 2 controller 2	
Operating timeout	0 - <b>1</b> - 10 minutes (0 = operating timeout is turned off)	
Scaling start	<b>0</b> - 9999	
Scaling end	0 - <b>9999</b>	

## 16 Appendix

Parameter	Selection / value range <b>Factory setting</b>	New setting
Signal source	<b>Main value</b> Not comp. Main value Temperature Option input 1 Option input 1 not compensated Option input 2 Option input 2 not compensated Option input 3 Option input 3 not compensated Math 1 Math 2 Differential signal Flow rate Partial quantity Total quantity	
Temperature unit	°C °F	
LCD inverse	<b>Off</b> On	
Contrast	0 - <b>10</b> - 20	

## 17. Disposal

---

### Note!

- Avoid environmental damage caused by media-contaminated parts
- Dispose of the device and packaging in an environmentally friendly manner
- Comply with applicable national and international disposal regulations and environmental regulations.

### Batteries

Batteries containing pollutants are marked with a sign consisting of a crossed-out garbage can and the chemical symbol (Cd, Hg, Li or Pb) of the heavy metal that is decisive for the classification as containing pollutants:

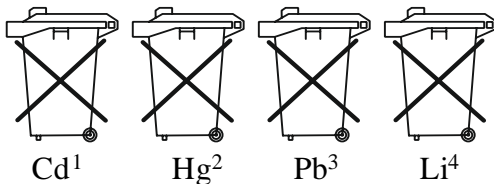

1. „Cd" stands for cadmium
2. Hg" stands for mercury
3. „Pb" stands for lead
4. Li" stands for lithium

### Electrical and electronic equipment

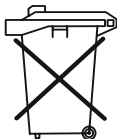

# 18 EU Declaration of Conformance

---

We, KOBOLD Messring GmbH, Hofheim-Ts, Germany, declare under our sole responsibility that the product:

**Transmitter/controller for conductivity, TDS, resistance, temperature and standard signals Model: ACM-1**

to which this declaration relates is in conformity with the standards noted below:

**EN 61326-1:2013** Electrical equipment for measurement, control and laboratory use - EMC requirements - Part 1: General requirements

**EN 61010-1:2010+A1:2019/AC:2019** Safety requirements for electrical equipment for measurement, control and laboratory use - Part 1: General requirements

Also the following EU guidelines are fulfilled:

<b>2014/30/EU</b>	EMC Directive
<b>2014/35/EU</b>	Low Voltage Directive
<b>2011/65/EU</b>	<b>RoHS</b>
<b>2015/863/EU</b>	Delegated Directive (RoHS III)

Hofheim, 08. März 2022



H. Volz  
General Manager



M. Wenzel  
Proxy Holder

## 19 UK Declaration of Conformance

---

We, KOBOLD Messring GmbH, Hofheim-Ts, Germany, declare under our sole responsibility that the product:

**Transmitter/controller for conductivity, TDS, resistance, temperature and standard signals Model: ACM-1**

to which this declaration relates is in conformity with the standards noted below:

**BS EN 61326-1:2013** Electrical equipment for measurement, control and laboratory use - EMC requirements - Part 1: General requirements

**BS EN 61010-1:2010+A1:2019/AC:2019** Safety requirements for electrical equipment for measurement, control and laboratory use - Part 1: General requirements

Also the following UK guidelines are fulfilled:

**S.I. 2016/1091** **Electromagnetic Compatibility Regulations 2016**

**S.I. 2016/1101** **Electrical Equipment (Safety) Regulations 2016**

**S.I. 2012/3032** The Restriction of the Use of Certain Hazardous Substances in Electrical and Electronic Equipment Regulations 2012

Hofheim, 08 March 2022



H. Volz  
General Manager



M. Wenzel  
Proxy Holder



**Manufactured and sold by:**

Kobold Messring GmbH  
Nordring 22-24  
D-65719 Hofheim  
Tel.: +49(0)6192-299-0  
Fax: +49(0)6192-23398  
E-Mail: [info.de@kobold.com](mailto:info.de@kobold.com)  
Internet: [www.kobold.com](http://www.kobold.com)

**Version: K08/0722**