



**Operating Instructions**  
**for**  
**Pressure Switch**  
**Model: SCH**



## 1. Contents

---

1. Contents.....	2
2. Note .....	3
3. Instrument Inspection.....	4
4. Regulation Use .....	5
4.1 Installation and Commissioning .....	5
4.2 Safety Instructions .....	6
5. Mechanical Connection.....	7
6. Electrical Connection .....	8
7. Setting the Switching Pressure .....	9
7.1 Setting the Switching Pressure with Plug Connection .....	9
7.2 Setting the Switching Point.....	9
7.3 Setting Switching Difference (only model V).....	10
8. Special Functions.....	11
8.1 Maximum- and Minimum Pressure Limiter (-205 and -206).....	11
8.2 Two Stage Pressure Switches (- 307 and - 217) .....	11
8.3 Switching Interval and Schematic Wiring Diagrams.....	13
8.4 Gold Plated Contacts (-213) .....	15
9. Technical Information.....	16
10. Order Codes .....	16
11. Disposal .....	17
12. EU Declaration of Conformance .....	18

### Manufactured and sold by:

Kobold Messring GmbH  
Nordring 22-24  
D-65719 Hofheim  
Tel.: +49(0)6192-2990  
Fax: +49(0)6192-23398  
E-Mail: info.de@kobold.com  
Internet: www.kobold.com

---

## 2. Note

---

Please read these operating instructions before unpacking and putting the unit into operation. Follow the instructions precisely as described herein.

The instruction manuals on our website [www.kobold.com](http://www.kobold.com) are always for currently manufactured version of our products. Due to technical changes, the instruction manuals available online may not always correspond to the product version you have purchased. If you need an instruction manual that corresponds to the purchased product version, you can request it from us free of charge by email ([info.de@kobold.com](mailto:info.de@kobold.com)) in PDF format, specifying the relevant invoice number and serial number. If you wish, the operating instructions can also be sent to you by post in paper form against an applicable postage fee.

Operating instructions, data sheet, approvals and further information via the QR code on the device or via [www.kobold.com](http://www.kobold.com)

The devices are only to be used, maintained and serviced by persons familiar with these operating instructions and in accordance with local regulations applying to Health & Safety and prevention of accidents.

When used in machines, the measuring unit should be used only when the machines fulfil the EC-machine guidelines.

**as per PED 2014/68/EU**

In acc. with Article 4 Paragraph (3), "Sound Engineering Practice", of the PED 2014/68/EU no CE mark.

## 3. Instrument Inspection

---

Instruments are inspected before shipping and sent out in perfect condition. Should damage to a device be visible, we recommend a thorough inspection of the delivery packaging. In case of damage, please inform your parcel service / forwarding agent immediately, since they are responsible for damages during transit.

**Scope of delivery:**

The standard delivery includes:

- Pressure Switch model: SCH

## **4. Regulation Use**

---

Any use of the “SCH”, which exceeds the manufacturers specification may invalidate its warranty. Therefore, any resulting damage is not the responsibility of the manufacturer. The user assumes all risk for such usage.

Pressure Switches are used for controlling and monitoring pressure in vessels of all kinds, e.g. for boilers, compressed air reservoirs, hydraulic and pneumatic plant, refrigeration engineering, water supply systems etc. Suitable types are available for overpressure, differential pressure and vacuum.

### **4.1 Installation and Commissioning**

- Pressure switches must be installed only by personnel trained in this application area (electric/hydraulic/mechanical) in accordance with the installation instructions and local legal requirements.
- The devices must be installed (mechanical, pressure-side connection) only on electro-chemically matched materials, otherwise there is risk of damage to base metals through contact corrosion which can result in loss of stability and leakage.
- Caution when touching device – risk of burns. Device can reach a medium temperature of up to 70 °C. Risk of freezing when working with media up to -20 °C.
- Do not open wiring-box or plug and do not remove terminal screws before the device is de-energized.

## 4.2 Safety Instructions

- The device must only be used within the electric, hydraulic and thermal limits specified in the data sheet.
- Inductive loads can cause contact burns or fuse the contacts. Preventative measures must be implemented by the customer, e.g., through use of suitable RC elements.
- When using the version with ZF 1979 (oil and grease-free), take care to avoid recontamination of surfaces that are in contact with media, right through from opening the packaging to completed installation. Generally, no liability will be assumed for oil and grease-free version.
- High quality stainless-steel sensor parts in contact with media enable the devices to be used with a variety of media. However, a chemical resistance test **MUST** be carried out before selection.
- Use with acids and other aggressive media, such as hydrofluoric acid, copper chloride, aqua regia or hydrogen peroxide, is not permitted.
- Use in systems with unstable gases and liquids such as hydrogen cyanide, dissolved acetylene or NO<sub>x</sub> is not permitted.
- Devices must be protected from solar radiation and rain.
- Pressure switches are precision devices which are calibrated in the factory. For this reason, never open the device and do not change the adjustment of the varnished calibration screws.
- Prevent excessive vibrations from reaching the pressure switch, e.g., with mechanical isolation or other vibration damping measures.
- Heavily contaminated media can clog the sensor and cause errors and/or malfunction. If the equipment is to be used for this purpose, suitable chemical seals must be connected.
- Pressure switches and chemical seals form a functional unit and must not be disconnected from each other in the field.
- Before disassembly (removing the pressure switch from the system), the device must be disconnected from the power supply and the system must be emptied. Observe the Accident Prevention Regulations.
- Never use the pressure switches as a climbing aid.
- KOBOLD Messring GmbH accepts no liability for non-compliance.

## 5. Mechanical Connection

### Installation

Install directly on the pipeline (pressure gauge connection G 1/2) or with 2 screws (4 mm) surface mounting. Tighten only on the hexagonal of the pressure connection, never use the housing or plug for fixing.

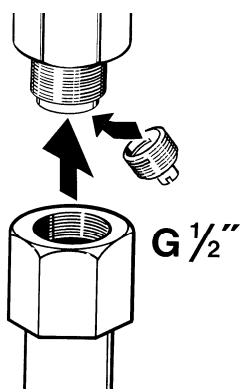

**External thread G 1/2**  
(Pressure gauge connection)  
When using flat seals, turn insert the centring screw.

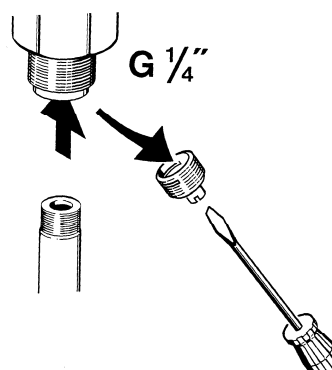

**Internal thread G 1/4**  
(Remove the centering peg )  
In gas application internal thread only up to 4 bar permissible. Use flat gasket ring for higher pressure.

### Connection

The differential Pressure Switches SCH- DDCM have 2x G 1/4 internal thread connections. Connect the high and the low pressure according to the marks.

**(+)** = high pressure

**(-)** = low pressure

When connecting attention should be paid to the marks.

## 6. Electrical Connection

---

- Ensure that the power is disconnected during connection of the cable.
- Wiring is on the angled plug.
- The cable outlet can be in any of 4 positions, which are at 90° in relation to each other.
- Remove screw
- Insert the screw driver in the slot and press downwards.
- On devices with terminal connection housing the terminal board is available after removing the terminal box lid.

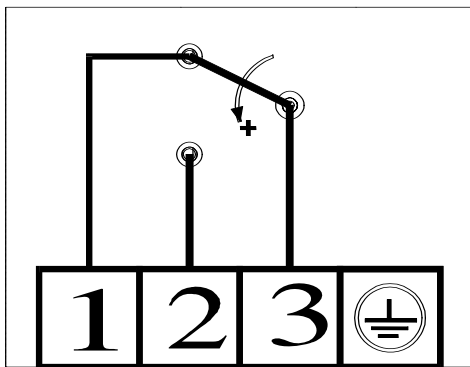

With rising pressure:  
3-1 opens, 3-2 closes

With falling pressure:  
3-2 opens, 3-1 closes



---

**Attention! The Pressure Switches are precision instruments, set and adjusted at the factory. Do not open the device or re-set the varnished adjustment screw. This would alter the switching points and resetting would be necessary.**

---



## 7. Setting the Switching Pressure

### 7.1 Setting the Switching Pressure with Plug Connection

The switching pressure is set using the setting spindle. Before setting loosen the locking screw located above the scale by approx. 2 turns and tighten it again after setting. The scale value corresponds to the upper switching point (for rising pressure). The lower switching point (for falling pressure) is lower by the value of switching difference. The scale serves only as an estimated value scale, a pressure gauge is required for accurate settings.

On the pressure switch housing, the setting screw is accessible after removing the cover.

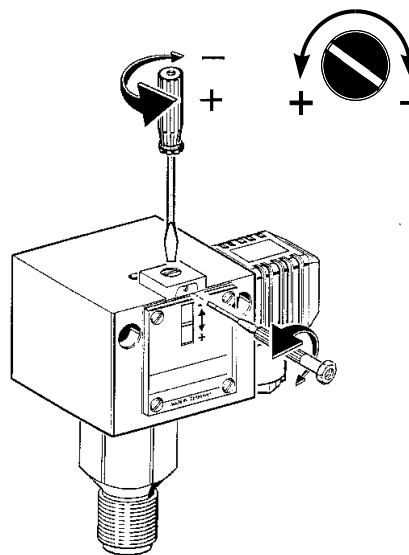

**Attention: Switch off voltage!**

#### Switching pressure

- turn to the right: lowers switch point
- turn to the left: raises switch point

### 7.2 Setting the Switching Point

The switching point can be set within the range given in the datasheet by using a screwdriver on the setting spindle. Additionally, you should remove the terminal board casing (with 4 hexagon screw M 4). The affixing screw on the front end (above the scale) has to be removed and should be reattached after setting the switching point.

Turning the setting spindle clockwise gives a lower switching point, turning anticlockwise gives a higher switching point.

The scale should be used as a guide, for more exact settings you should use a manometer.

## Serial Numbers

All switch units and their respective terminal board casings are marked with a serial number. When installing you should ensure that the terminal board casings do not get mixed up.

### 7.3 Setting Switching Difference (only model V)

One spindle each is available for setting the switching pressure and the switching difference. Both spindles are arranged concentrically. The outer spindle, with larger diameter, adjusts the lower switching point; the switching difference, and thus the upper switching point, is changed with the small central screw located internally.

The action direction is indicated by the arrow direction.

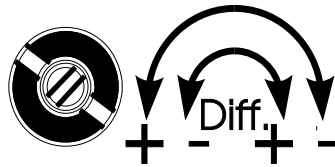

#### Setting sequence

- Adjust the lower switching point (with decreasing pressure), with outer spindle, according to scale or pressure gauge.
- Adjust the switching difference (with increasing pressure), with small, internal central screw, results in setting the upper switching point.

When the switching difference is changed, the lower switch-off point remains unchanged, the upper switching point is shifted by the switching difference.

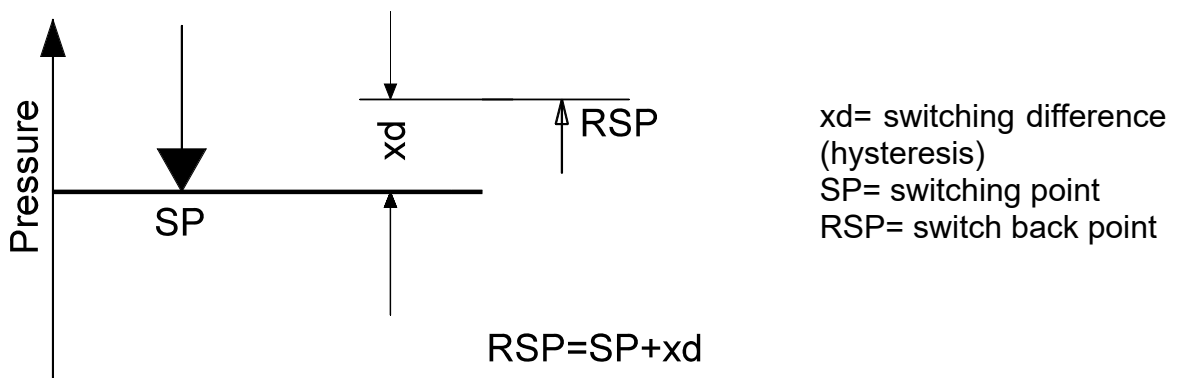

## 8. Special Functions

### 8.1 Maximum- and Minimum Pressure Limiter (-205 and -206)

Instead of a microswitch with automatic reset, a "bistable" microswitch is installed in the limiters. When the pressure reaches the value set on the scale, the microswitch switches over and remains in the position.

- **Unlocking**

The catch can be released by pressing in the unlocking button (marked on the scale side of the switching device by a red dot.) The limiter can not be unlocked until the pressure has decreased by a certain amount or, in the case of interlocking at the lower switching point, is increased again. Depending on the version, the interlock can be effective for a rising value (max. limiter ...-205) or for a falling value (min. limiter ...206).

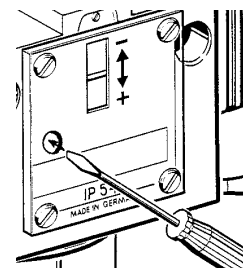

Minimum pressure limiter

Maximum pressure limiter

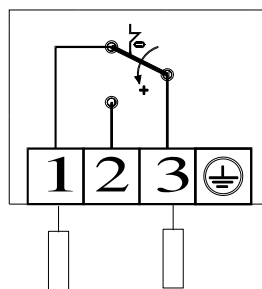
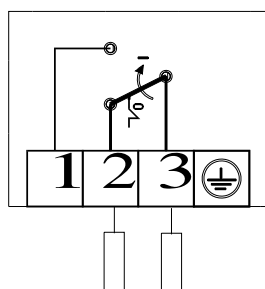

### 8.2 Two Stage Pressure Switches (- 307 and - 217)

A switch-unit, with two microswitches both with single-poled changeover, forms part of the basic equipment for each two-stage Pressure Switch.

- The first switch I monitors lower pressure
- The second switch II monitors higher pressure.
- It should be noted that the switching differentials of the individual microswitches cannot be exactly identical because of their component tolerances.
- The switching interval of both microswitches is the interval (in bar or mbar) between the switching points of both microswitches.

**Applies for all variations:**

Changes to the setting spindle, to the setting of switching pressure, do not lead to changes in the switching intervals as the switching points are adjusted correspondingly. The switching differential of the individual microswitches corresponds to the switching differences listed under basic equipment.

The switching differential cannot be set for individual microswitches in two-stage Pressure Switches.

- **Two stage Pressure Switch - 307**

The switching interval between both switches is set according to the customer's requirements. With increasing pressure first microswitch I (terminal connection 1-3) and then microswitch II (terminal connection 4-6) is activated.

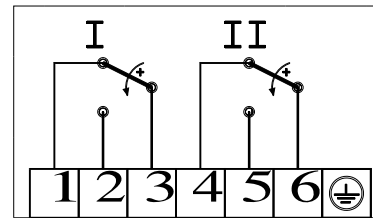

- **Two stage Pressure Switch - 217**

as in -209 however the switching interval can be set within given limits.

- Setting wheel I CW-reduce switching point at microswitch I
- Setting wheel II CCW-raise switching point at microswitch II

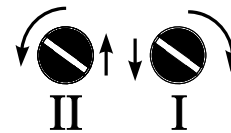

Setting wheels I and II have an internal stop to ensure that the microswitches cannot be adjusted past their effective range.



---

**Attention: Note the sticker besides the plug connection of Pressure Switch.**

---

### 8.3 Switching Interval and Schematic Wiring Diagrams

Switching interval of two stage Pressure Switch (Option 217, 307)				
Model	Min. switching interval		Max. switching interval (average value)	
	Factory-set	Schematic wiring diagram A1/A3/B2/B4 C1/C3/D2/D4 + Option 307	Schematic wiring diagram A2/A4/C2/C4	Schematic wiring diagram B1/B3/D1/D3
DCM 06	25 mbar	165 mbar	190 mbar	140 mbar
DCM 025	20 mbar	140 mbar	160 mbar	120 mbar
DCM 1	40 mbar	240 mbar	280 mbar	200 mbar
DCM 6/DNM 6	0.15 bar	0.95 bar	1.2 bar	0.8 bar
DCM 10	0.25 bar	1.6 bar	1.85 bar	1.35 bar
DCM 16	0.3 bar	2.0 bar	2.3 bar	1.7 bar
DCM 40	0.9 bar	6.0 bar	6.9 bar	5.1 bar
DCM 63	1.3 bar	8.5 bar	9.8 bar	7.2 bar
DDCM 1	0.09 bar	0.55 bar	0.64 bar	0.46 bar
DDCM 6	0.14 bar	0.94 bar	1.08 bar	0.8 bar
DNM 06	40 mbar	240 mbar	270 mbar	200 mbar
DNM 025	35 mbar	215 mbar	240 mbar	180 mbar
VCM 095	40 mbar	300 mbar	340 mbar	260 mbar
VCM 101	40 mbar	260 mbar	300 mbar	220 mbar
VCM 301	20 mbar	100 mbar	120 mbar	80 mbar
VNM 111	50 mbar	310 mbar	360 mbar	260 mbar

#### Order reference for Extradunction ZF217

Schematic wiring diagram	Switchgear	Orderposition	Extratext
A1	A	DCM6-217A-S	Schematic wiring diagram A1
A2	C	DCM6-217C-S	Schematic wiring diagram A2
A3	C	DCM6-217C-S	Schematic wiring diagram A3
A4	A	DCM6-217A-S	Schematic wiring diagram A4
B1	B	DCM6-217B-S	Schematic wiring diagram B1
B2	D	DCM6-217D-S	Schematic wiring diagram B2
B3	D	DCM6-217D-S	Schematic wiring diagram B3
B4	B	DCM6-217B-S	Schematic wiring diagram B4
C1	B	DCM6-217B-S	Schematic wiring diagram C1
C2	D	DCM6-217D-S	Schematic wiring diagram C2
C3	D	DCM6-217D-S	Schematic wiring diagram C3
C4	B	DCM6-217B-S	Schematic wiring diagram C4
D1	A	DCM6-217A-S	Schematic wiring diagram D1
D2	C	DCM6-217C-S	Schematic wiring diagram D2
D3	C	DCM6-217C-S	Schematic wiring diagram D3
D4	A	DCM6-217A-S	Schematic wiring diagram D4

## Schematic wiring diagram for Option 217

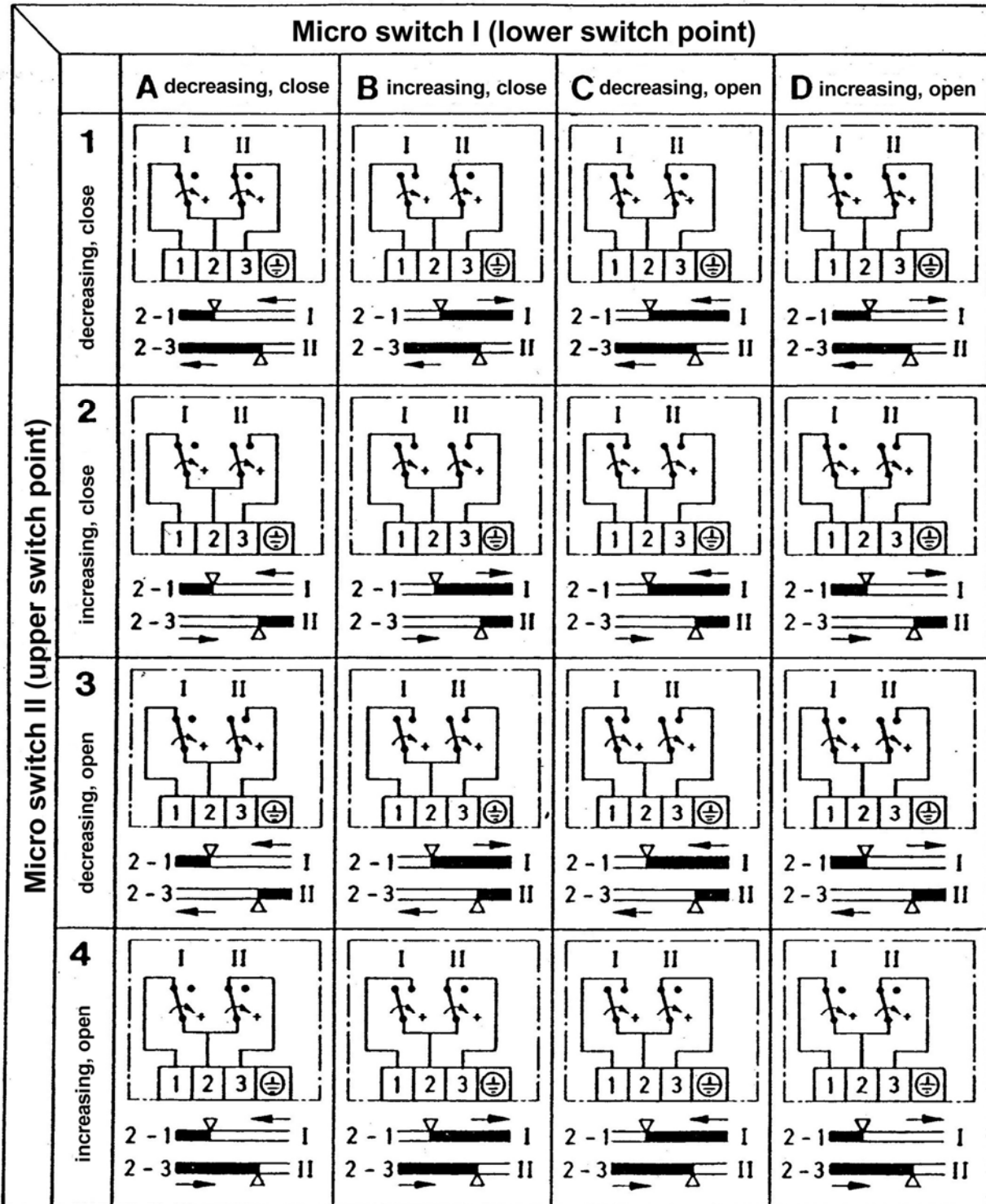

## Adjustment

The addition of the adjustment with setting wheels I and II provides the switching interval between the two microswitches. Changes made at the setpoint spindle do not affect the switching interval; the switching interval remains constant over the entire adjustment range of the spindle, the two switching points being displaced up or down in parallel.

- 1) Turn setting wheel I fully CCW. Turn setting wheel II fully CW. The lowest switching interval is adjusted.
- 2) Set setpoint spindle S to a value on the scale which is central between the required top and required bottom switching point.
- 3) With pressure applied, set bottom switching point with setting wheel I (a1)
- 4) With setting wheel II, proceed as under 3. above to set top switching point (a2).
- 5) If the required top and bottom switching point cannot be obtained, adjust setpoint spindle S in the necessary direction and repeat setting as per 3. and 4. above.

Example:

Desired switching points: 3,8 and 3,2 bar  
Adjustment according point 2: S=3,5 bar

- Set bottom switching point (3,2 bar) with setting wheel I (turn to the right)
- Set top switching point (3,8 bar) with setting wheel II (turn to the left).

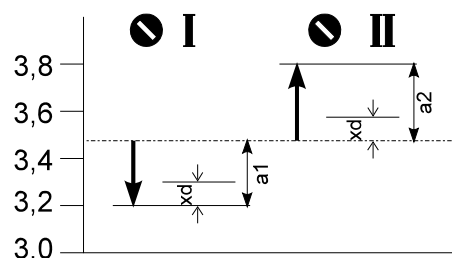

## 8.4 Gold Plated Contacts (-213)

Gold plated contacts are used exclusively in the low voltage range in order to keep the transit resistance at the contact low. Switch points see standard types. Switching capacity: min. 4 mA, 5 V<sub>DC</sub> ; max. 100 mA, 24 V<sub>DC</sub>.

At higher voltages and currents the gold layer on the contacts will be damaged.

## 9. Technical Information

---

Operating instructions, data sheet, approvals and further information via the QR code on the device or via [www.kobold.com](http://www.kobold.com)

## 10. Order Codes

---

Operating instructions, data sheet, approvals and further information via the QR code on the device or via [www.kobold.com](http://www.kobold.com)



## 11. Disposal

### Note!

- Avoid environmental damage caused by media-contaminated parts
- Dispose of the device and packaging in an environmentally friendly manner
- Comply with applicable national and international disposal regulations and environmental regulations.

### Batteries

Batteries containing pollutants are marked with a sign consisting of a crossed-out garbage can and the chemical symbol (Cd, Hg, Li or Pb) of the heavy metal that is decisive for the classification as containing pollutants:

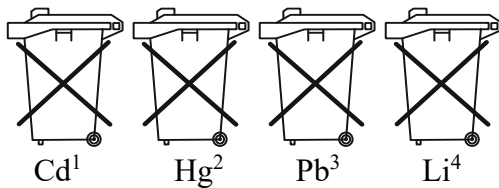

1. „Cd" stands for cadmium
2. „Hg" stands for mercury
3. „Pb" stands for lead
4. „Li" stands for lithium

### Electrical and electronic equipment

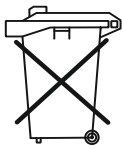

## 12. EU Declaration of Conformance

---

We, KOBOLD Messring GmbH, Hofheim-Ts, Germany, declare under our sole responsibility that the product:

**Pressure Switch**

**Model: SCH-...**

to which this declaration relates is in conformity with the standards noted below:

**EN 60730-1** Safety of household and similar Electrical appliances  
**EN 60730-2-6** Part 1: General requirements

Also, the following EC guidelines are fulfilled:

**2014/35/EU** **Low Voltage Directive**  
**2011/65/EU** **RoHS** (category 9)  
**2015/863/EU** Delegated Directive (RoHS III)

Hofheim, 30 March 2023



H. Volz  
General Manager



M. Wenzel  
Proxy Holder